

AHTI

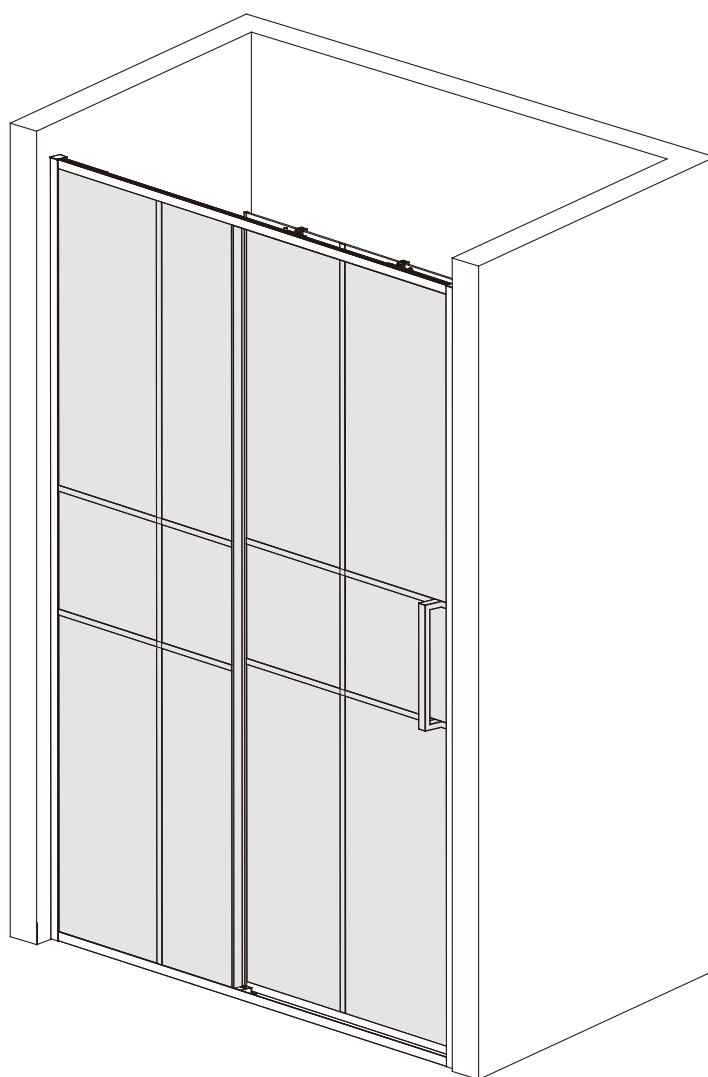
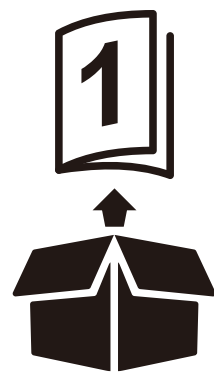

5059340077796

BX220IM

GoodHome 



EN Contents
RO Cuprins
TR İçindekiler

FR Contenu
ES Contenido

PL Zawartość
PT Conteúdo



Safety

5

FR	Sécurité	5
PL	Bezpieczeństwo	6
RO	Siguranță	6
ES	Seguridad	7
PT	Segurança	8
TR	Emniyet	8



Guarantee

5

FR	Garantie	5
PL	Gwarancja	6
RO	Garanție	6
ES	Garantía	7
PT	Garantia	8
TR	Garanti	8



Assembly

12

FR	Assemblage	12
PL	Montaż	12
RO	Asamblare	12
ES	Montaje	12
PT	Montagem	12
TR	Montaj	12



Care and maintenance

35

FR	Entretien et Maintenance	35
PL	Czyszczenie i konserwacja	35
RO	Îngrijire și întreținere	35
ES	Cuidados y Mantenimiento	35
PT	Cuidados e Manutenção	35
TR	Bakım ve Onarım	35



EN WARNING! Please read all safety warnings carefully and be sure that they are fully understood before handling the product.

FR AVERTISSEMENT ! Avant de manipuler le produit, il est nécessaire d'avoir lu attentivement et parfaitement compris tous les avertissements de sécurité.

PL OSTRZEŻENIE! Przed przystąpieniem do użytkowania produktu należy dokładnie przeczytać wszystkie ostrzeżenia bezpieczeństwa oraz upewnić się, że zostały w pełni zrozumiane.

RO AVERTISMENT! Citiți cu atenție toate avertismentele de siguranță și asigurați-vă că au fost complet înțelese înainte de manevrarea produsului.

ES ¡ATENCIÓN! Lea todas las instrucciones de seguridad con detenimiento y asegúrese de que las ha entendido completamente antes de manipular el producto.

PT AVISO! Leia atentamente todos os avisos de segurança e certifique-se de que estes são totalmente compreendidos antes de manusear o produto.

TR UYARI! Lütfen tüm güvenlik uyarılarını dikkatle okuyun ve ürün üzerinde çalışmaya başlamadan önce hepsini iyice anladığınızdan emin olun.

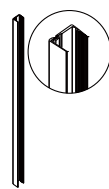
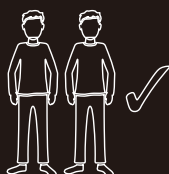

[01] x 2



[04] x 1



[05] x 1

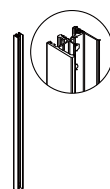

[08] x 1



[09] x 1

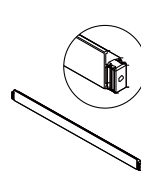

[10] x 1



[13] x 1



[14] x 1



[15a] x 1



[15b] x 1

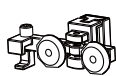

[16a] x 1

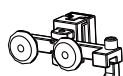

[16b] x 1



[17a] x 1

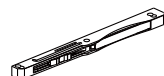

[17b] x 1



[18] x 2



[19] x 1



[20] x 1



[21] x 1

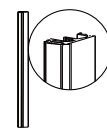

[22] x 1

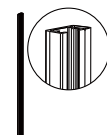

[23] x 1



[24] x 2

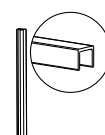

[25] x 1

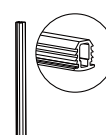

[26] x 1

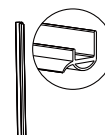

[27a] x 1

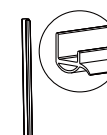

[27b] x 1

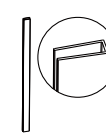

[28] x 1



[34] x 1



[36] x 6



[37] x 1

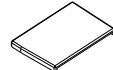

[38a] x 1

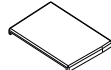

[38b] x 1



St4x10mm

[42] x 4

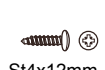

St4x12mm

[43] x 4

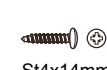

St4x14mm

[44] x 1

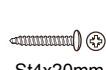

St4x20mm

[45] x 2

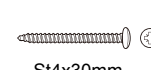

St4x30mm

[46] x 6



[48] x 1

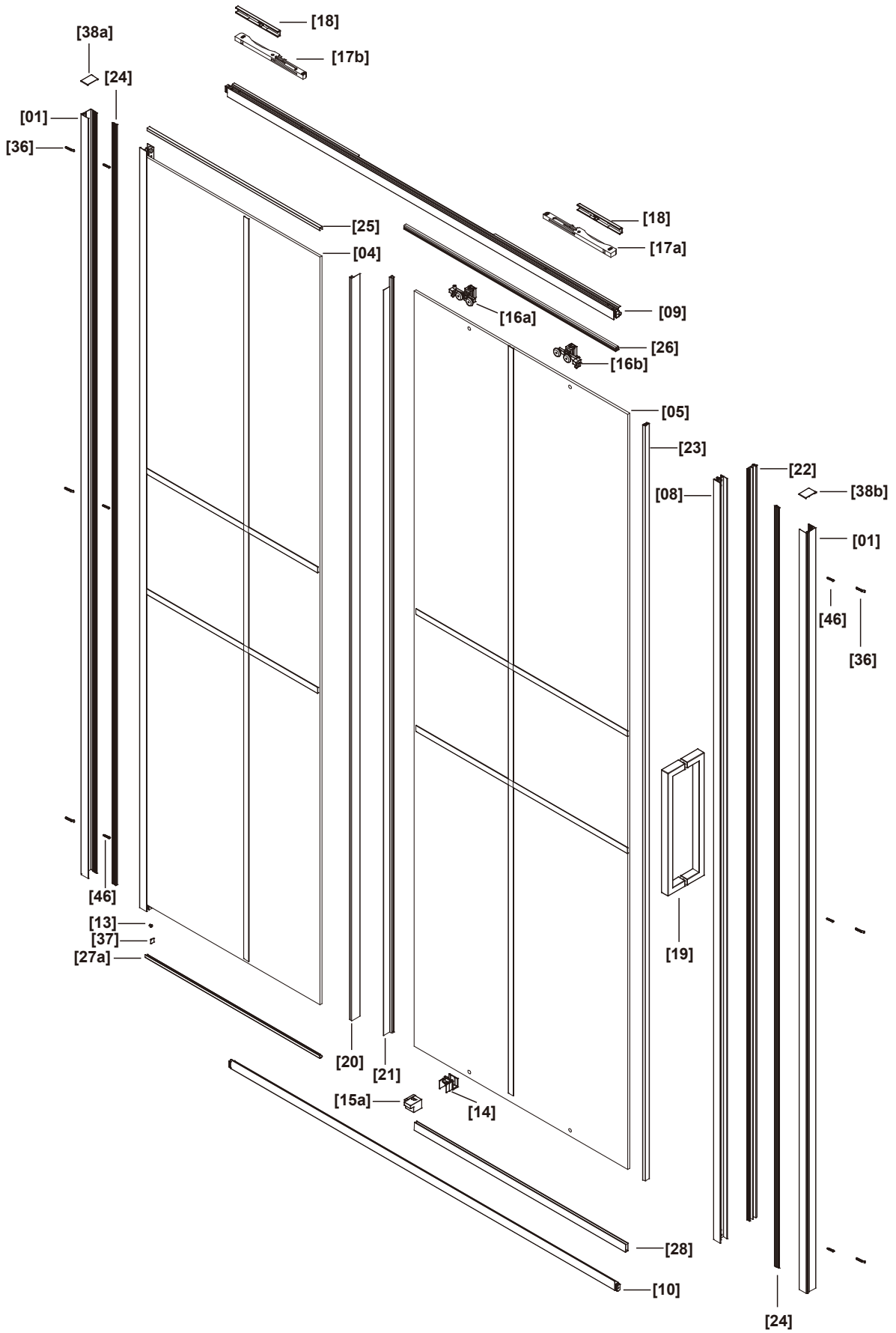



EN Safety
RO Siguranță
TR Emniyet

FR Sécurité
ES Seguridad

PL Bezpieczeństwo
PT Segurança

EN

Getting Started...

- Check the pack and ensure that you have all of the parts listed.
- When you are ready to start, make sure you have the right tools to hand, plenty of space and a dry area for assembly.
- Ensure the mounting surface is sound, clean and dry before the enclosure is installed.
- Ensure that the enclosure is fitted to a level tray or floor and vertical walls.
- The thickness of the tiles used will affect the overall position of the enclosure on the tray.
- When drilling through ceramic tiles use a specialist drill bit.
- When working near a tray or bath, ensure that the waste is covered so that small parts do not fall down it.
- Please note: The wall plugs included with this product are suitable for solid walls only. Other wall types may require specialist fixings or wall plugs (not provided). Always ensure that wall plugs or fittings are correct for the wall type. If in doubt seek professional advice.
- Please note that although these instructions are comprehensive, it is always recommended that a technically competent installer should undertake the installation.

Safety

- For domestic use only.
- **CAUTION:** Fragile - handle the product with care.
- This product may cause personal injury, property damage or break easily if not handled, positioned and installed with care.
- **CAUTION:** Please handle all glass with care. Any damage to the edges, or scratches to the surface that occur during assembly or normal use can cause the glass to break suddenly. Tempered glass will shatter into very small pieces that will still have sharp edges.
- Do not strike the glass with hard or pointed items.
- Do not attempt to cut the glass.
- **CAUTION:** Always ensure the product is securely installed before use.
- Care should be taken when drilling into walls to avoid any hidden pipes or wires.
- **CAUTION:** When drilling through ceramic tiles use a specialist drill bit.
- **CAUTION:** DO NOT overtighten the fixings otherwise it may damage the product.

WARNING: Failure to follow these instructions may result in personal injury, damage to the product and property damage.

Guarantee

This shower enclosure is under warranty for 5 years from the purchase date for normal household, non-professional use. The warranty is valid only upon presentation of the sales slip or purchase invoice. Keep your proof of purchase in a safe place.

The warranty covers product breakdowns and malfunctions subject to compliance with the product's intended use and subject to proper installation and maintenance in accordance with the information in the user guide.

The shower enclosures must be installed so that they can be later removed, without causing damage. This contractual warranty does not cover defects and deterioration caused by the natural wear of the parts, colour variations due to the influence of light over time, bad weather, floods, heat, damage caused by water quality (hardness, abrasiveness, corrosion, etc.), by the presence of foreign objects, whether transported or not by water (sand, filings, etc.) or the lack of room ventilation and damages that could be the result of improper use, misuse, negligence, accident or faulty maintenance.

The following are also excluded from warranty claims: adverse effects due to the use of non-genuine or unsuitable accessories and/or replacement parts, product disassembly or product modification.

The warranty does not cover the breakage of tempered glass enclosures, whether it occurs during unpacking, assembly or transportation of the product, or after its installation.

The warranty is limited to parts recognised as defective. In no case shall it cover ancillary costs (travel, labour) and direct and indirect damages.

Guarantee related queries should be addressed to a store affiliated with the distributor you purchased the product from.

This guarantee is in addition to and does not affect your statutory rights. Declaration of Performance available on www.diy.com

IMPORTANT - RETAIN THIS INFORMATION FOR FUTURE REFERENCE: READ CAREFULLY

FR

Pour bien commencer...

- Vérifiez le contenu du paquet et assurez-vous que tous les composants répertoriés sont présents.
- Lorsque vous êtes prêt pour commencer, veillez à disposer des bons outils à portée de main, de suffisamment d'espace et d'un endroit se pour le montage.
- Assurez-vous que la surface de montage est solide, propre et sèche avant l'installation de la paroi.
- Assurez-vous que la paroi est fixée à un bac ou sol nivelé et à des murs verticaux.
- L'épaisseur des carreaux utilisés affectera la position d'ensemble de la paroi sur le receveur.
- Lors de perçages dans des carreaux en céramique, utilisez un foret adapté.
- Lors de travaux effectués à proximité d'un bac ou d'une baignoire, assurez-vous que les ouvertures soient couvertes afin qu'aucun petit morceau n'y tombe.
- Remarque : les chevilles murales fournies avec ce produit conviennent pour les murs pleins uniquement. Les autres types de murs peuvent éventuellement nécessiter des fixations ou chevilles murales spéciales (non fournies). Assurez-vous toujours que les chevilles murales ou fixations sont adaptées au type de mur. En cas de doute, obtenez des conseils professionnels.
- Remarque importante : Bien que ces instructions soient complètes, il est toujours recommandé que l'installation soit réalisée par un installateur professionnel.

Sécurité

- Utilisation domestique uniquement.
- **ATTENTION :** Fragile - manipulez le produit avec précaution. Ce produit peut causer des blessures, des dommages matériels ou se casser facilement s'il n'est pas manipulé, disposé et installé avec soin.
- **ATTENTION :** Veuillez manipulez toute vitre avec précaution. Tout endommagement des bords ou rayure sur la surface susceptible de se produire en cours de montage ou d'utilisation normale peut provoquer la cassure soudaine de la vitre. La vitre trempée peut voler en petits éclats, dont les bords sont tout de même tranchants.
- Ne cognez pas la vitre avec des objets durs ou pointus.
- Ne tentez pas de découper la vitre.
- **ATTENTION :** Assurez-vous toujours que le produit est correctement installé avant de l'utiliser.
- Des précautions doivent être prises lors des perçages dans le mur pour éviter les tuyaux et les fils cachés.
- **ATTENTION :** Lors de perçages dans des carrelages en céramique, utilisez un foret spécial.
- **ATTENTION :** NE serrez PAS les fixations excessivement. Cela pourrait endommager le produit.

AVERTISSEMENT : Le non-respect de ces instructions peut entraîner des blessures corporelles, des dommages au produit et des dommages à la propriété.

Garantie

Cette paroi de douche est garantie 5 ans à compter de la date d'achat, dans le cadre d'un usage ménager normal, non professionnel. La garantie ne peut s'appliquer que sur présentation du ticket de caisse ou de la facture d'achat. Conservez votre preuve d'achat dans un endroit sûr.



EN Safety
RO Siguranță
TR Emniyet

FR Sécurité
ES Seguridad

PL Bezpieczeństwo
PT Segurança

06

La garantie couvre les pannes et dysfonctionnements du produit sous réserve d'une utilisation conforme à la destination du produit et sous réserve d'une installation et d'un entretien conformes aux règles de l'art et aux informations du manuel d'utilisation.

Les parois de douche devront avoir été installées de telle sorte qu'elles puissent être retirées ultérieurement, sans détérioration. Cette garantie contractuelle ne couvre pas les défauts et détériorations provoqués par l'usure naturelle des pièces, les variations de teinte dues à l'influence de la lumière dans le temps, les intempéries, les inondations, les dégagements de chaleur, les dommages causés par la qualité de l'eau (calcaire, agressivité, corrosion, ...), par la présence de corps étrangers véhiculés ou non par l'eau (sable, limailles, ...) ou le manque d'aération de la pièce et les dommages qui pourraient être la conséquence d'un usage inapproprié, d'une utilisation abusive, d'une négligence, d'un accident ou d'un entretien défectueux.

Sont également exclues de la garantie les conséquences néfastes dues à l'emploi d'accessoires et/ou de pièces de rechange non d'origine, ou non adaptées, au démontage ou à la modification du produit.

La garantie ne couvre pas la casse des parois en verre trempé, qu'elle intervienne durant le déballage, le montage, le transport du produit, ou après son installation.

La garantie est limitée aux pièces reconnues défectueuses. Elle ne couvre, en aucun cas, les frais annexes (déplacement, main d'oeuvre) et les dommages directs et indirects.

Indépendamment de cette garantie commerciale, le vendeur reste tenu de la garantie légale de conformité mentionnée aux articles L. 217-4 à L. 217-12 et de celle relative aux défauts de la chose vendue, dans les conditions prévues aux articles 1641 à 1648 et 2232 du code civil.

Article L217-4 du code de la consommation :

Le vendeur livre un bien conforme au contrat et répond des défauts de conformité existant lors de la délivrance.

Il répond également des défauts de conformité résultant de l'emballage, des instructions de montage ou de l'installation lorsque celle-ci a été mise à sa charge par le contrat ou a été réalisée sous sa responsabilité.

Article L217-5 du code de la consommation :

Le bien est conforme au contrat :

1° S'il est propre à l'usage habituellement attendu d'un bien semblable et, le cas échéant :

- s'il correspond à la description donnée par le vendeur et possède les qualités que celui-ci a présentées à l'acheteur sous forme d'échantillon ou de modèle ;

- s'il présente les qualités qu'un acheteur peut légitimement attendre eu égard aux déclarations publiques faites par le vendeur, par le producteur ou par son représentant, notamment dans la publicité ou l'étiquetage ;
2° Ou s'il présente les caractéristiques définies d'un commun accord par les parties ou est propre à tout usage spécial recherché par l'acheteur, porté à la connaissance du vendeur et que ce dernier a accepté.

Article L217-12 du code de la consommation :

L'action résultant du défaut de conformité se prescrit par deux ans à compter de la délivrance du bien.

Article L217-16 du code de la consommation :

Cette période court à compter de la demande d'intervention de l'acheteur ou de la mise à disposition pour réparation du bien en cause, si cette mise à disposition est postérieure à la demande d'intervention.

Article 1641 du code civil :

Le vendeur est tenu de la garantie à raison des défauts cachés de la chose vendue qui la rendent impropre à l'usage auquel on la destine, ou qui diminuent tellement cet usage que l'acheteur ne l'aurait pas acquise, ou n'en aurait donné qu'un moindre prix, s'il les avait connus.

Article 1648 alinéa 1er du code civil :

L'action résultant des vices rédhibitoires doit être intentée par l'acquéreur dans un délai de deux ans à compter de la découverte du vice.

Ceci n'affecte pas vos droits légaux.

Lorsque l'acheteur demande au vendeur, pendant le cours de la garantie commerciale qui lui a été consentie lors de l'acquisition ou de la réparation d'un bien meuble, une remise en état couverte par la garantie, toute période d'immobilisation d'au moins sept jours vient s'ajouter à la durée de la garantie qui restait à courir.

Pour toutes requêtes relatives à la garantie, veuillez-vous adresser à un magasin affilié au distributeur auprès duquel vous avez acheté ce produit.

Déclaration de performance disponible sur www.castorama.fr et www.bricodepot.fr

IMPORTANT - A CONSERVER POUR CONSULTATION ULTERIEURE : A LIRE SOIGNEUSEMENT

PL

Pierwsze kroki...

- Sprawdź zawartość opakowania, aby upewnić się, że znajdują się w nim wszystkie części.
- Przed rozpoczęciem montażu upewnij się, że posiadasz odpowiednie narzędzia, wystarczająco dużo miejsca oraz suchą przestrzeń pod montaż.
- Przed rozpoczęciem instalacji kabiny upewnij się, że powierzchnia montażu jest stabilna, czysta i sucha.
- Upewnij się, że kabina została przymocowana do wypoziomowanego brodzika lub podłogi oraz do pionowej ściany.
- Grubość położonych na ścianie kafelków ma wpływ na ostateczną pozycję ułożenia kabiny na brodziku.
- Do wiercenia przez kafelki ceramiczne używaj specjalnego wiertła.
- Podczas pracy w okolicy brodzika lub wanny, upewnij się, że odpływ jest zamknięty, dzięki czemu małe części nie mogą do niego wpaść.
- Informacja: Kolki rozporowe dołączone do produktu są przeznaczone wyłącznie do montażu na litych ścinach. Montaż na ścianach innego typu wymaga specjalnych elementów montażowych lub kołków rozporowych (nie dołączone). Zawsze upewnij się, że kolki rozporowe i elementy montażowe są właściwie dobrane dla danego typu ściany. W razie wątpliwości zasięgnij porady specjalisty.
- Pamiętaj. Pomimo, że instrukcje instalacji są kompleksowe, to zawsze zalecane jest przeprowadzenie montażu przez wykwalifikowanego fachowca.

Bezpieczeństwo

- Produkt przeznaczony do użytku domowego.
- **UWAGA:** Szkło - bądź ostrożny podczas obchodzenia się z produktem. Niniejszy produkt może doprowadzić do urazu użytkownika, uszkodzenia mienia lub może stłuc się, jeśli należyta ostrożność nie zostanie zachowana podczas instalacji.
- **UWAGA:** Proszę zachować ostrożność podczas obchodzenia się z szybami. Jakiegokolwiek uszkodzenia krawędzi lub zadrapania powierzchni spowodowane podczas montażu bądź normalnego użycia, mogą doprowadzić do nagiego stłuczenia się szyby.
- Szkło hartowane rozkruszy się na bardzo małe kawałki z ostrymi krawędziami.
- Nie uderzaj w szyby twardymi lub spiczastymi przedmiotami.
- Nie przecinaj szyb.
- **UWAGA:** przed użyciem zawsze upewnij się, że produkt jest bezpiecznie zainstalowany.
- Zachowaj ostrożność podczas wiercenia ściany, aby nie uszkodzić rur oraz przewodów elektrycznych.
- **UWAGA:** Do wiercenia przez kafelki ceramiczne używaj specjalnego wiertła.
- **UWAGA:** NIE dokręcaj mocowań zbyt mocno, gdyż może to uszkodzić produkt.

OSTRZEŻENIE: Nie przestrzeganie niniejszych instrukcji może doprowadzić do urazu użytkownika, zniszczenia lub uszkodzenia mienia.

Gwarancja

Gwarancja drzwi prysznicowych jest ważna 5 lat/a od daty zakupu, w ramach normalnego użytku w gospodarstwie domowym a nie w środowisku profesjonalnym. Gwarancja jest ważna wyłącznie po okazaniu paragonu lub faktury zakupu. Prosimy zachować dowód zakupu w bezpiecznym miejscu.



EN Safety
RO Siguranță
TR Emniyet

FR Sécurité
ES Seguridad

PL Bezpieczeństwo
PT Segurança

07

Gwarancja obejmuje usterki i niewłaściwe działanie produktu, z zastrzeżeniem stosowania zgodnie z przeznaczeniem produktu i instalacji oraz konserwacji zgodnych z zasadami dobrej praktyki i z informacjami zawartymi w instrukcji użytkownika.

Drzwi prysznicowe należy zainstalować tak, by mogły być później demontowane bez uszkodzenia. Gwarancja umowna nie obejmuje wad i uszkodzeń spowodowanych naturalnym zużyciem części, zmian koloru pod wpływem światła w czasie, czynników pogodowych, powodzi, wytwarzanie ciepła, uszkodzeń spowodowanych jakością wody (wapień, korozja ..), obecnością obcych ciał przenoszonych w wodzie lub poza nią (piasek, opiłki ..) lub brak wentrowania pomieszczenia oraz uszkodzeń na skutek niewłaściwego lub niedbałego użytkowania, niezgodnego z przeznaczeniem, wypadku lub wadliwej konserwacji.

Szkodliwe skutki spowodowane używaniem nieoryginalnych, niedostosowanych akcesoriów i/lub części zamiennych, demontażem lub zmianą produktu są również wyłączone z gwarancji.

Gwarancja nie obejmuje zbitcia drzwi ze szkła hartowanego, które nastąpiło podczas rozpakowywania, montażu, transportu produktu lub po instalacji.

Gwarancja jest ograniczona do części uznanych za wadliwe. Nie obejmuje ona w żadnym razie dodatkowych kosztów (dojazd, siła robocza) oraz bezpośrednich i pośrednich uszkodzeń

W ramach gwarancji Kupujący może uzyskać zwrot zapłaconej ceny albo wymianę produktu lub jego naprawę lub inne usługi, których skutkiem będzie usunięcie wad produkcyjnych. Kupujący jest zobowiązany do współdziałania z Gwarantem przy realizacji swoich uprawnień wynikających z niniejszej gwarancji. Kupujący, który korzysta z uprawnień wynikających z niniejszej gwarancji powinien dostarczyć produkt na podany niżej adres Gwaranta lub do sklepu, w którym go nabył.

Gwarant zobowiązuje się do wykonania swoich obowiązków niezwłocznie, ale nie później niż w terminie 21 dni.

Udzielenie przez Gwaranta gwarancji nie wyłącza, nie ogranicza ani nie zawiesza uprawnień Kupującego wynikających z przepisów o rękojmi za wady rzeczy sprzedanej.

Deklaracja właściwości użytkowych dostępna na www.castorama.pl

WAŻNE - ZACHOWAJ TE INFORMACJE DO WYKORZYSTANIA W PRZYSZŁOŚCI: PRZECZYTAJ UWAŻNIE

RO

Pentru început...

- Verificați pachetul și asigurați-vă că toate componentele trecute pe listă sunt prezente.
- Când sunteți gata, asigurați-vă că aveți sculele adecvate la îndemână, suficient spațiu și o zonă uscată pentru asamblare.
- Asigurați-vă că suprafața de montare este adecvată, curată și uscată înainte de instalarea cabinei de duș.
- Asigurați-vă că produsul este montat pe o câdiță sau sol drept și pereți verticali.
- Cabina este proiectată pentru a permite de 8mm când este montată între pereți autentici.
- Grosimea plăcilor de faianță utilizate va influența poziția generală a cabinei pe câdița de duș.
- Când găuriți prin plăci ceramice, utilizați un burghiu specializat.
- Când lucrați în apropierea unei câdițe sau căzi de baie, asigurați-vă că gaura de scurgere este acoperită astfel încât să se împiedice căderea pieselor mici în aceasta.
- Vă rugăm, notați: Diblurile incluse cu acest produs sunt adecvate numai pentru pereți solizi. Alte tipuri de pereți pot necesita elemente profesionale de fixare sau dibluri (neincluse). Întotdeauna asigurați-vă că diblurile sau elementele de fixare sunt corecte pentru tipul de perete. În caz de dubiu, consultați un expert.
- Vă rugăm notați că deși aceste instrucțiuni sunt complete, întotdeauna se recomandă ca instalarea să fie executată de un instalator cu competențe tehnice.

Siguranță

- Numai pentru utilizare casnică.
- **ATENȚIE:** Fragil - manevrați produsul cu grijă. Acest produs poate cauza răni, pagube sau se poate sparge ușor dacă nu este manevrat poziționat și instalat cu grijă.
- **ATENȚIE:** Vă rugăm manevrați cu grijă toate produsele de sticlă. Oricare deteriorare a muchiilor sau zgârieturi ale suprafețelor care pot avea loc în timpul asamblării sau a utilizării normale pot cauza spargerea bruscă a sticlei. Sticla călită se va sparge în bucățele foarte mici care vor avea muchii ascuțite.
- Nu loviți sticla cu articole ascuțite sau dure.
- Nu încercați să tăiați sticla.
- **ATENȚIE:** Întotdeauna asigurați-vă că produsul este bine instalat înainte a utilizării.
- Aveți grijă când dați găuri în pereți pentru a evita țevile sau firele electrice ascunse.
- **ATENȚIE:** Când găuriți prin plăci ceramice, utilizați un burghiu specializat.
- **ATENȚIE:** Nu strângeți excesiv fittingurile deoarece riscați să avariați produsul.

AVERTIZARE: Nerespectarea acestor instrucțiuni se poate solda cu vătămare corporală, deteriorarea produsului și deteriorarea bunurilor.

Garantie

Acest perete de duș este garantat 5 ani de la data achiziției, în condiții de utilizare casnică normală, nu profesională.

Garanția poate fi aplicată numai pe baza prezentării bonului fiscal de casă sau a facturii.

Păstrați dovada achiziției într-un loc sigur.

Garanția acoperă defectele și disfuncționalitățile produsului sub rezerva unei utilizări în conformitate cu scopul propus al produsului și sub rezerva unei instalări și a unei întrețineri în conformitate cu cele mai bune practici și cu informațiile din manualul de utilizare.

Pereții de duș trebuie să fie instalați astfel încât aceștia să poată fi demontați ulterior fără deteriorare.

Această garanție contractuală nu acoperă defectele și deteriorările provocate de uzura naturală a pieselor, de variațiile de nuanță datorate influenței luminii în timp, de intemperii, de inundații, de degajările de căldură, de deteriorările provocate de calitatea apei (calcar, agresivitate, coroziune, ...), de prezența unor corpuri străine vehiculate sau nu de apă (nisip, particule, ...) sau de lipsa ventilației camerei și de daunele care ar putea să fie rezultatul utilizării necorespunzătoare, al unei utilizări abuzive, al neglijenței, al unui accident sau al unei întrețineri defectuoase.

De asemenea, sunt excluse din garanție consecințele negative datorate utilizării de accesorii și/sau piese de schimb neoriginale sau neadaptate, demontării sau modificării produsului.

Garanția nu acoperă spargerea pereților din sticlă tratată termic, care intervine în timpul dezambalării, al montajului, al transportului produsului sau după instalare.

Garanția este limitată la piesele recunoscute ca fiind defecte.

Garanția nu acoperă, în niciun caz, costurile auxiliare (de deplasare, de manoperă) și daunele directe și indirecte.

Acest lucru nu afectează drepturile dumneavoastră statutare. Această garanție nu acoperă kitul de evacuare.

Vă rugăm să rețineți că un certificat de garanție suplimentar va fi dat în magazinul din care veți achiziționa produsul.

Declarație de performanță disponibilă pe www.bricodepot.ro

IMPORTANT - PĂSTRAȚI ACESTE INFORMAȚII PENTRU CONSULTĂRI VIITOARE: CITIȚI CU ATENȚIE



EN Safety
RO Siguranță
TR Emniyet

FR Sécurité
ES Seguridad

PL Bezpieczeństwo
PT Segurança

ES

Empezando...

- Compruebe y asegúrese de que cuenta con todos los componentes de la lista.
- Cuando esté listo para comenzar, asegúrese de que tiene a mano las herramientas adecuadas, mucho espacio y una zona seca para el montaje.
- Compruebe que la superficie del montaje sea sólida, esté limpia y seca antes de instalar la cabina.
- Asegúrese que la cabina esté ajustada a una bandeja nivelada o al piso y que las paredes están verticales.
- El grosor de los azulejos utilizados afectará la posición general en la cabina sobre la bandeja.
- Cuando taladre azulejos de cerámica utilice una broca especial para ello.
- Cuando trabaje cerca de una bandeja o una tina, asegúrese que el desagüe esté cubierto para que las partes pequeñas no caigan por ahí.
- Por favor tenga en cuenta: los tarugos de pared incluidos con este producto son aptos solo para muros sólidos. Otros tipos de muros podrían necesitar métodos de fijación especiales (no incluidos). Asegúrese siempre de que los tarugos o accesorios de instalación sean los correctos para el tipo de muro. Si tiene dudas al respecto, busque la ayuda de un profesional.
- Por favor tenga en cuenta que aunque estas instrucciones están completas, siempre se recomienda que un instalador competente técnicamente se haga cargo de la instalación.

Seguridad

- Para uso exclusivo doméstico.
- **PRECAUCIÓN:** Frágil - maneje el producto con cuidado. Este producto puede causar lesiones personales, daños a la propiedad o romperse fácilmente si no se maneja, coloca e instala con cuidado.
- **PRECAUCIÓN:** Por favor maneje el vidrio con cuidado. Los bordes pueden dañarse o las superficies pueden rayarse durante el montaje o uso normal causando que el vidrio se rompa repentinamente. El vidrio templado se desmoronará en pedazos muy pequeños que tendrán bordes afilados.
- No golpee el vidrio con artículos duros o puntiagudos.
- No intente cortar el vidrio.
- **PRECAUCIÓN:** asegúrese siempre de que el producto está instalado de forma segura antes de utilizarlo.
- Tenga cuidado al taladrar para evitar tuberías o cableado oculto.
- **PRECAUCIÓN:** Cuando taladre azulejos de cerámica utilice una broca especial para ello.
- **PRECAUCIÓN:** NO apriete en exceso los elementos de fijación o podría dañar el producto.

PRECAUCIÓN: No seguir estas instrucciones puede dar como resultado lesiones personales, daño al producto y daños a la propiedad.

Garantía

Esta mampara de ducha tiene una garantía de 5 años a partir de la fecha de compra, en el ámbito de un uso doméstico normal, no profesional. La garantía solo tendrá validez mediante presentación del ticket de caja o la factura de compra. Guarde su comprobante de compra en un lugar seguro.

La garantía cubre las averías y el mal funcionamiento del producto, a condición de que se utilice para el uso al que se destina el producto y a condición de que la instalación y el mantenimiento tengan conformidad con las buenas prácticas del sector y con el manual de instrucciones.

Las mamparas de ducha deben haberse instalado de tal manera que se puedan retirar después, sin deterioro. Esta garantía contractual no cubre los defectos ni el deterioro provocados por el desgaste natural de las piezas, las variaciones de color debidas a la influencia de la luz a lo largo del tiempo, de la intemperie, las inundaciones, las emisiones de calor, los daños causados por la calidad del agua (cal, agresividad, corrosión ...), por la presencia de cuerpos extraños traídos o no por el agua (arena, limaduras ...) o la falta de aireación de la estancia y los daños que pudieran derivarse de un uso inadecuado, abusivo, una negligencia, un accidente o un mantenimiento defectuoso.

También quedan excluidas de la garantía las consecuencias nefastas del

uso de accesorios y/o piezas de recambio no originales, no adaptadas, del desmontaje o modificación del producto.

La garantía no cubre la rotura de las mamparas de vidrio templado en ningún caso, ni si se produce durante el desembalaje, el montaje, el transporte del producto ni después de su instalación.

La garantía queda limitada a las piezas reconocidas como defectuosas. No cubre, en ningún caso, los gastos relacionados (desplazamiento, mano de obra) y los daños directos e indirectos.

Brico Dépot queda responsable de los defectos de conformidad del producto según lo establecido por los artículos 114 a 124 del Real Decreto Legislativo 1/2007, de 16 de noviembre, por el que se aprueba el texto refundido de la Ley General para la Defensa de los Consumidores y Usuarios y otras leyes complementarias.

Declaración de rendimiento disponible en www.bricodepot.es

IMPORTANTE - GUARDE ESTA INFORMACIÓN PARA FUTURAS CONSULTAS: LEA ATENTAMENTE

PT

Iniciar...

- Verifique a embalagem e certifique-se de que não faltam peças.
- Quando estiver pronto para começar, certifique-se de que tem as ferramentas necessárias e espaço suficiente numa zona seca para executar a montagem.
- Certifique-se de que a superfície de montagem está em boas condições, limpa e seca antes de instalar a divisória.
- Certifique-se de que a divisória é colocada numa base ou piso nivelado e com paredes verticais.
- A divisória foi concebida de forma a permitir um ajuste de 8mm quando instalada em "paredes falsas".
- A espessura dos azulejos usados afeta a posição geral do fecho na base.
- Ao perfurar azulejos de cerâmica, utilize uma broca especial.
- Ao trabalhar junto de uma base de chuveiro ou banheira, certifique-se de que não existe a possibilidade de entrada de resíduos.
- Tenha em atenção o seguinte: As buchas incluídas neste produto adequam-se apenas a paredes sólidas. Outros tipos de parede poderão necessitar de acessórios de fixação ou buchas especiais (não fornecidos). Certifique-se sempre de que as buchas ou o acessórios de fixação adequam-se ao tipo de parede. Em caso de dúvida, consulte um profissional.
- Embora estas instruções sejam abrangentes, é sempre recomendável que a instalação seja executada por um profissional com as devidas qualificações.

Segurança

- Apenas para uso doméstico.
- **ATENÇÃO:** Frágil - manusear o produto com cuidado. Este produto pode causar lesões pessoais, danos na propriedade ou partir-se facilmente se não for manuseado, posicionado e instalado com cuidado.
- **ATENÇÃO:** Manuseie todas as partes de vidro com cuidado. Quaisquer danos nas extremidades, ou riscos na superfície, que ocorram durante a montagem ou a utilização normal podem fazer com que o vidro quebre repentinamente. O vidro temperado fragmenta-se em várias peças pequenas que terão extremidades aguçadas.
- Não bata no vidro com objetos rígidos ou pontiagudos.
- Não tente cortar o vidro.
- **ATENÇÃO:** Certifique-se sempre de que o produto está devidamente instalado antes de utilizá-lo.
- É necessário ter cuidado ao perfurar paredes para evitar qualquer tipo de tubagem ou cablagem.
- **ATENÇÃO:** Ao perfurar azulejos de cerâmica, utilize uma broca especial.
- **ATENÇÃO:** NÃO aperte demasiado os acessórios de fixação, caso



EN Safety
RO Siguranță
TR Emniyet

FR Sécurité
ES Seguridad

PL Bezpieczeństwo
PT Segurança

09

contrário, poderá danificar o produto.

AVISO: O não seguimento destas instruções pode dar origem a lesões pessoais, danos no produto e danos de propriedade.

Garantia

Esta parede de chuveiro tem uma garantia de 5 anos a partir da data de compra, no âmbito de uma utilização doméstica normal, não profissional. A garantia só pode ser aplicada mediante apresentação do talão de caixa ou fatura de compra. Guarde a sua prova de compra num local seguro.

A garantia abrange as avarias e mau funcionamento do produto, sob reserva de uma utilização em conformidade com os intuitos para que o produto foi criado e sob reserva de uma instalação e manutenção em conformidade com as regras da arte e as informações do manual de utilização.

As paredes de chuveiro deverão ter sido instaladas de modo a que possam ser retiradas posteriormente, sem deterioração. Esta garantia contratual não abrange defeitos e deteriorações provocados por um desgaste natural das peças, variações de cor devido à influência da luz com o passar do tempo, intempéries, inundações, libertações de calor, danos causados pela qualidade da água (calcário, agressividade, corrosão ...), pela presença de corpos estranhos veiculados ou não pela água (areia, limalhas ...) ou a falta de arejamento da peça e os danos que poderão ser consequência de uma utilização inadequada, uma utilização abusiva, negligência, acidente ou manutenção defeituosa.

Estão também excluídas da garantia as consequências nefastas devido à utilização de acessórios e/ou peças sobresselentes que não sejam originais ou não adaptadas, à desmontagem ou modificação do produto.

A garantia não abrange a quebra das paredes em vidro temperado, quer ocorra durante o desempacotamento, montagem, transporte do produto ou após a sua instalação.

A garantia limita-se às peças reconhecidas como defeituosas. Ela não abrange, em caso algum, as despesas resultantes (deslocamento, mão-de-obra) e os danos diretos ou indiretos.

Brico Depot é responsável por defeitos de conformidade do produto conforme nos termos da Lei das Garantias (Decreto-Lei n.0 67/2003, alterado pelo Decreto-Lei n.0 84/2008).

Declaração de desempenho disponível em www.bricodepot.pt

IMPORTANTE - GUARDE ESTA INFORMAÇÃO PARA REFERÊNCIA FUTURA: LER CUIDADOSAMENTE

TR

Başlarken...

- Listede bulunan tüm parçalara sahip olduğunuzdan emin olun.
- Başlamaya hazır olduğunuzda doğru aletlerin hazır olduğundan, yeterli kadar geniş ve kuru bir montaj alanına sahip olduğunuzdan emin olun.
- Kabin kurulmadan önce montaj yüzeyinin sağlam, temiz ve kuru olduğundan emin olun.
- Kabinin düz bir tekne ya da zemin üzerine ve dikey duvarlara takıldığından emin olun.
- Kullanılan tayansiarın kalınlığı kabinin tekne üzerindeki genel duruşunu etkileyecektir.
- Seramik tayansiarda delik açarken özel matkap uçları kullanın.
- Bir tekneyada küvetin yanında çalışırken, küçük parçaların içine düşmemesi için giderin örtülü olduğundan emin olun.
- Lütfen not edin: Bu ürünle birlikte verilen dübeller sadece sert duvarlarda kullanım için uygundur. Diğer duvar tipleri özel bağlantı parçaları veya dübelleri (ürüne dahil değildir) gerektirebilir. Daima dübel veya bağlantı parçalarının duvar tipi için doğru seçildiğinden emin olun. Bu konuda kafanızda soru işaretleri oluşursa bir uzmana danışın.
- Bu talimatlar kapsamlı olmakla birlikte, kurulumun daima teknik açıdan

yetkin bir montaj uzmanı tarafından yapılması tavsiye edilir.

Emniyet

- Sadece ev kullanımı içindir.
- DIKKAT:** Kırılgan - ürünü dikkatli kullanın. Bu ürün dikkatli taşınmaz, yerleştirilmez ve monte edilmezse kişisel yaralanma veya mal hasarına yol açabilir veya kolayca kırılabilir.
- DIKKAT:** Lütfen tüm camları dikkatlice taşıyın. Montaj veya normal kullanım sırasında meydana gelen kenarlardaki hasarlar veya yüzeyindeki çizikler camın aniden kırılmasına neden olabilir. Temperlenmiş cam çok küçük parçalara ayrılacak olsa da, bunlar yine de keskin kenarları bulunan parçalardır.
- Camı sert veya sivri uçlu nesnelere vurmayın.
- Camı kesmeye çalışmayın.
- DIKKAT:** Kullanım öncesinde mutlaka ürünün güvenli bir şekilde monte edildiğinden emin olun.
- Matkapla duvara delik açarken gizli boru veya kabiovara karşı dikkatli olunmalıdır.
- DIKKAT:** Seramik tayansiarda delik açarken özel matkap uçları kullanın.
- DIKKAT:** Bağlantı parçalarını aşırı SIKMAYIN, aksi takdirde ürün hasar görebilir.

UYARI: Bu talimatiara uyulmaması kişisel yaralanma, ürün ve mal hasarı ile sonuçlanabilir.

Garanti

Bu duşakabin profesyonel amaçlı olmayan normal ev kullanımı kapsamında satın alma tarihinden itibaren 5 yıl garantilidir. Garanti, sadece kasa fişi veya faturanın ibraz edilmesi halinde geçerlidir. Satın aldığınızı gösteren belgeyi güvenli bir yerde saklayın.

Bu garanti, ürünün kullanım amacına uygun kullanılması, kurallara ve kullanma kılavuzundaki bilgilere uygun bir montaj ve bakıma tabi tutulması kaydıyla üründeki hataları ve kusurları kapsar.

Duşakabinlerin daha sonra tahribata uğramadan sökülebilecek şekilde monte edilmeleri gerekir. Sözleşmeye dayalı bu garanti, parçaların doğal aşınmasından, gün işiği etkisiyle renk değişimlerinden, kötü hava şartlarından, sel baskınlarından, isinmadan kaynaklanan hata ve tahribatlardan, su kalitesinden (kireç, agresivite/çözücülük, korozyon, ...), suyla taşınan yabancı maddelerin varlığı (kum, talaş, ...) veya odanın havalandırılmamasından kaynaklı hasarları ve hatallı kullanım, hor kullanım, ihmal, kaza ya da yanlış yapılmış bir bakımın sonucu oluşabilecek hasarları kapsamaz.

Garanti aynı şekilde, orijinal olmayan veya adaptasyonu yapılmamış aksesuarların ve/veya yedek parçaların kullanılmasına, ürünün sökülmesine veya ürün üzerinde değişiklik yapılmasına bağlı yan etkileri kapsamaz.

Garanti ambalajın açılması, montaj, ürünün taşınması sırasında veya montajdan sonra duşakabinin temperli cam panellerinde meydana gelen kırık ve çatlakları kapsamaz.

Garanti, hatallı olduğu belirlenen parçalarla sınırlıdır. Bu garanti, hiçbir durumda sigorta poliçe masraflarını (nakliyat, işçilik), doğrudan ve dolaylı hasarları kapsamaz.

Garanti ambalajın açılması, montaj, ürünün taşınması sırasında veya montajdan sonra duşakabinin temperli cam panellerinde meydana gelen kırık ve çatlakları kapsamaz.

www.koctas.com.tr adresinde mevcut olan performans beyanı

İthalatçı Firma: KOÇTA YAPI MARKETLERİ TIC. A..

Tasdelen Mah. Sırrı Çelik Bulvarı No: 5

34788 Tasdelen/Çekmeköy/İSTANBUL

Tel: +90 216 4300300 Faks: +90 216 4844313 www.koctas.com.tr

Yetkili servis istasyonları ve yedek parça temini için aşağıda yer alan Koçtaş Müşteri Hattı ve Koçtaş Genel Müdürlük irtibat bilgilerinden faydalanınız.

KOÇTAŞ MÜŞTERİ HİZMETLERİ

0850 209 50 50



EN Safety
RO Siguranță
TR Emniyet

FR Sécurité
ES Seguridad

PL Bezpieczeństwo
PT Segurança

10

**ÖNEMLİ – BU BİLGİLERİ
DAHA SONRA KULLANMAK
ÜZERE SAKLAYIN: DİKKATLE
OKUYUN**

CE

Kingfisher International Products B.V.
Rapenburgerstraat 175E
1011 VM Amsterdam, The Netherlands
www.kingfisher.com/products

20

DoP_C53263_5059340077796_1

5059340077796

PH - HP - IP

Do higieny osobistej

EN14428:2015

CA-IR-DA



EN Safety
RO Siguranță
TR Emniyet

FR Sécurité
ES Seguridad

PL Bezpieczeństwo
PT Segurança



- EN CAUTION:** Be careful of cutting edges. Wear gloves during installation.
- FR ATTENTION :** Faites attention aux bords coupants. Portez des gants lors de l'installation.
- PL PRZESTROGA:** Uważać na ostrza tnące. Nosić rękawice podczas montażu.
- RO ATENȚIE:** Aveți grijă la marginile ascuțite. Purtați mănuși în timpul instalării.
- ES PRECAUCIÓN:** Tenga cuidado con los filos cortantes. Use guantes durante la instalación.
- PT ATENÇÃO:** Tenha cuidado com arestas afiadas. Use luvas durante a instalação.
- TR DİKKAT:** Keskin kenarlara dikkat edin. Kurulum sırasında eldiven takın.



EN Assembly
RO Asamblare
TR Montaj

FR Assemblage
ES Montaje

PL Montaż
PT Montagem

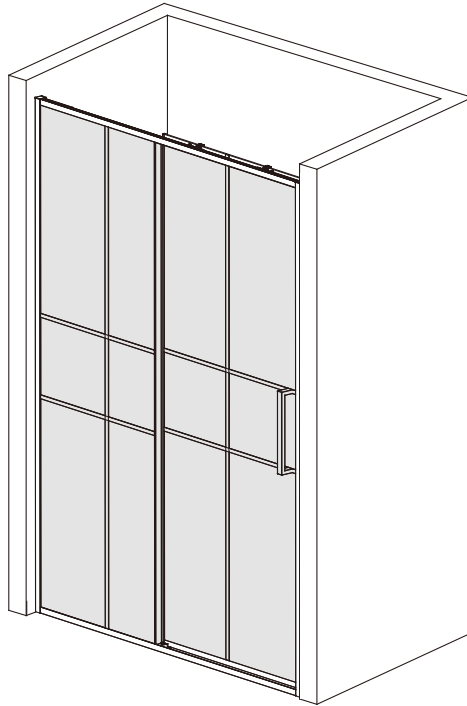

Pg.13--23

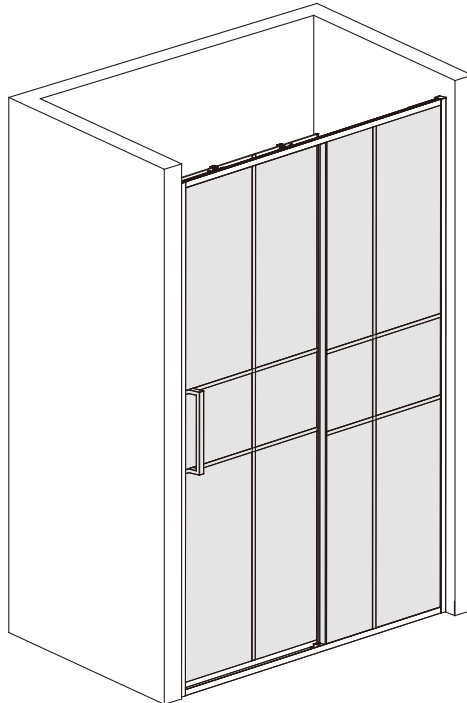

Pg.24--34



EN Assembly
RO Asamblare
TR Montaj

FR Assemblage
ES Montaje

PL Montaż
PT Montagem

01

-  **EN** Note: Ensure that the sides of the glass panels with the Easy Clean treatment logo on are positioned facing inward.
- FR** Remarque : Assurez-vous que les faces des panneaux en verre avec le logo nettoyage facile sont positionnées face vers l'intérieur.
- PL** Informacja: Upewnij się, że obie strony szyb pokrytych powłoką "Easy Clean" są skierowane do wewnątrz.
- RO** Notă: Asigurați-vă că panourile de sticlă cu fațada tratată cu Easy Clean sunt poziționate în spre interiorul cabinei.
- ES** Nota: Asegúrese que los lados de los paneles de vidrio con tratamiento de Easy Clean estén colocados hacia el interior.
- PT** Nota: Nota: Certifique-se de que os lados dos painéis de vidro com o tratamento Easy Clean estão voltados para dentro.
- TR** Not: Cam panellerin, üzerinde Kolay Temizlik uygulaması bulunan yüzeyinin içe doğru bakacak şekilde konumlanmış olduğundan emin olun.



[01] x 1



[36] x 6



St4x30mm

[46] x 3

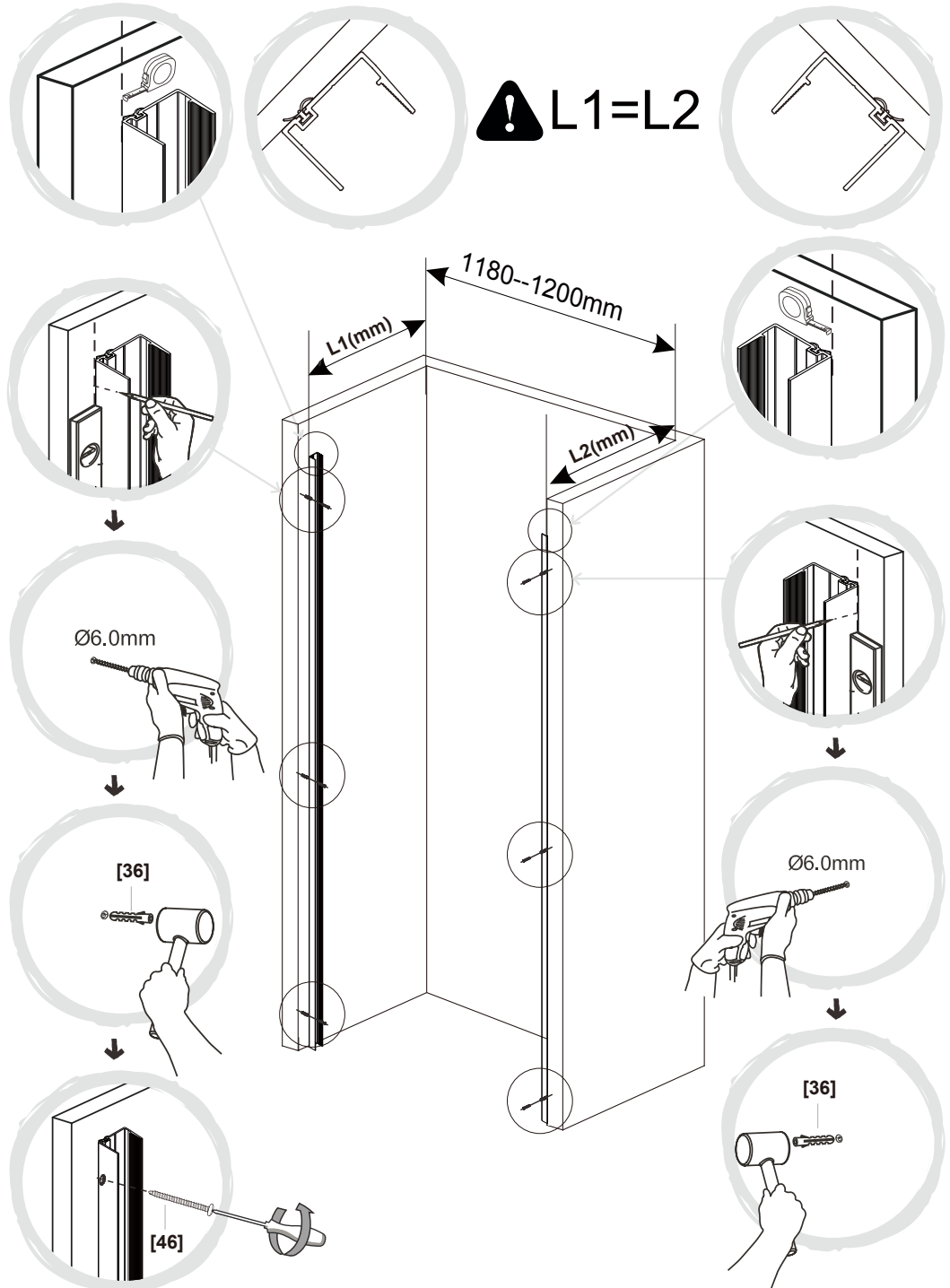



EN Assembly
RO Asamblare
TR Montaj

FR Assemblage
ES Montaje

PL Montaż
PT Montagem

02

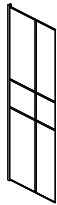

[04] x 1

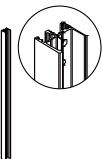

[08] x 1



[09] x 1

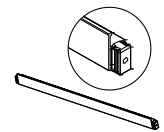

[10] x 1



[15a] x 1

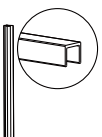

[25] x 1

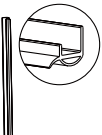

[27a] x 1



St4x12mm
[43] x 4



St4x14mm
[44] x 1

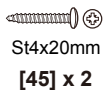

St4x20mm
[45] x 2

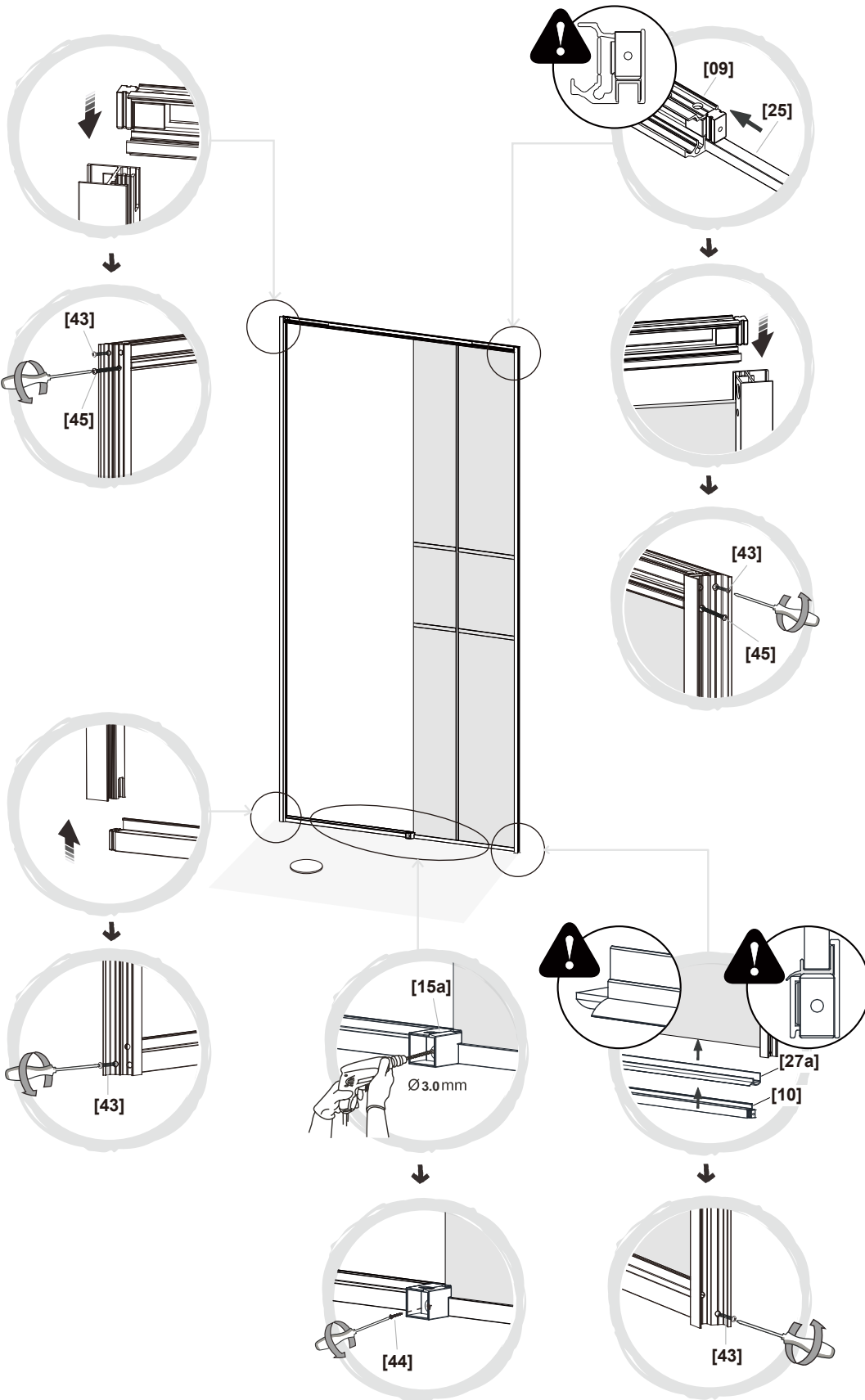



EN Assembly
RO Asamblare
TR Montaj

FR Assemblage
ES Montaje

PL Montaż
PT Montagem

03

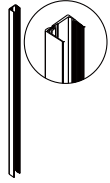

[01] x 1



St4x30mm

[46] x 3

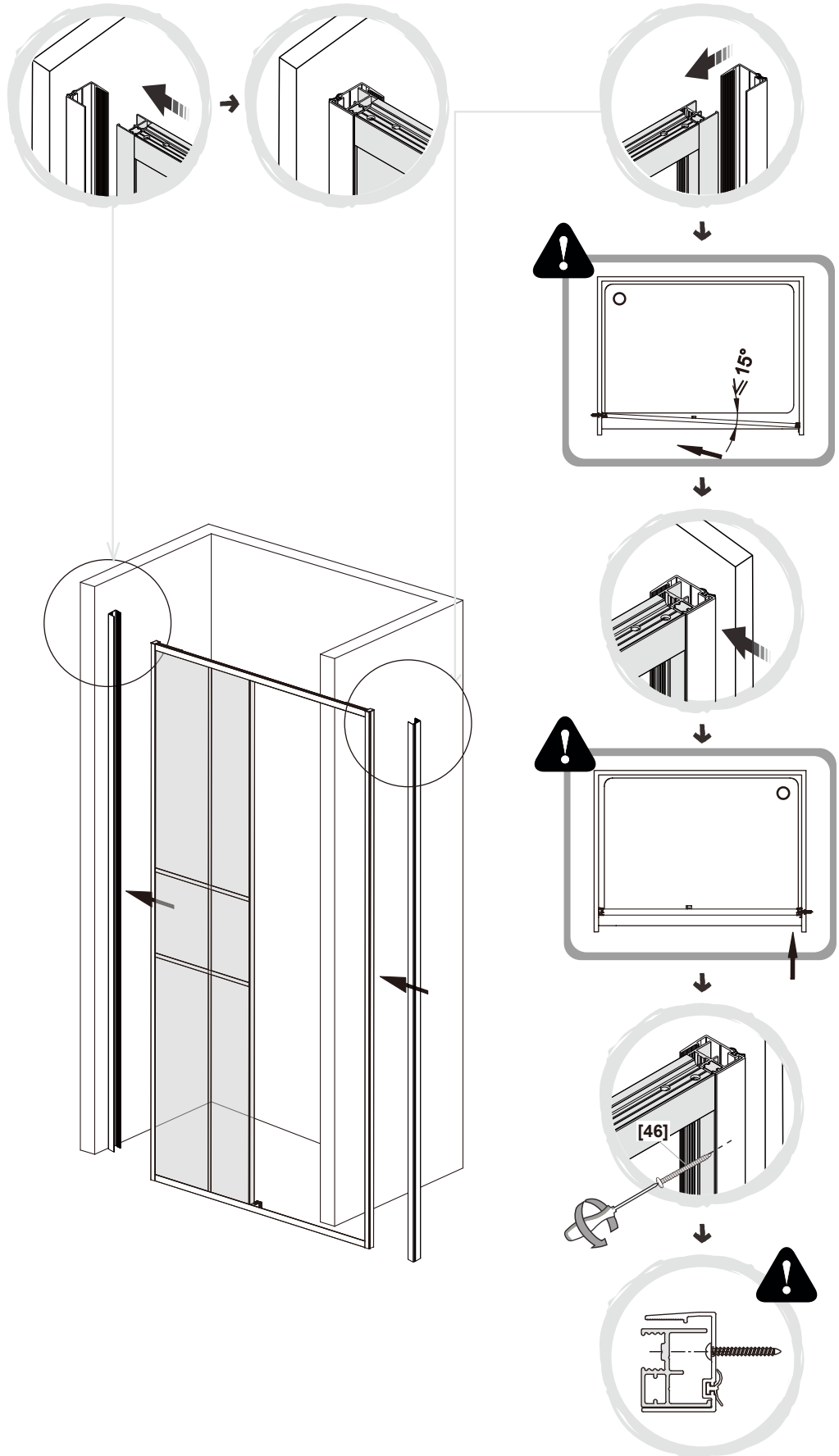



04



[17a] x 1



[17b] x 1



[18] x 2



S4x10mm

[42] x 4

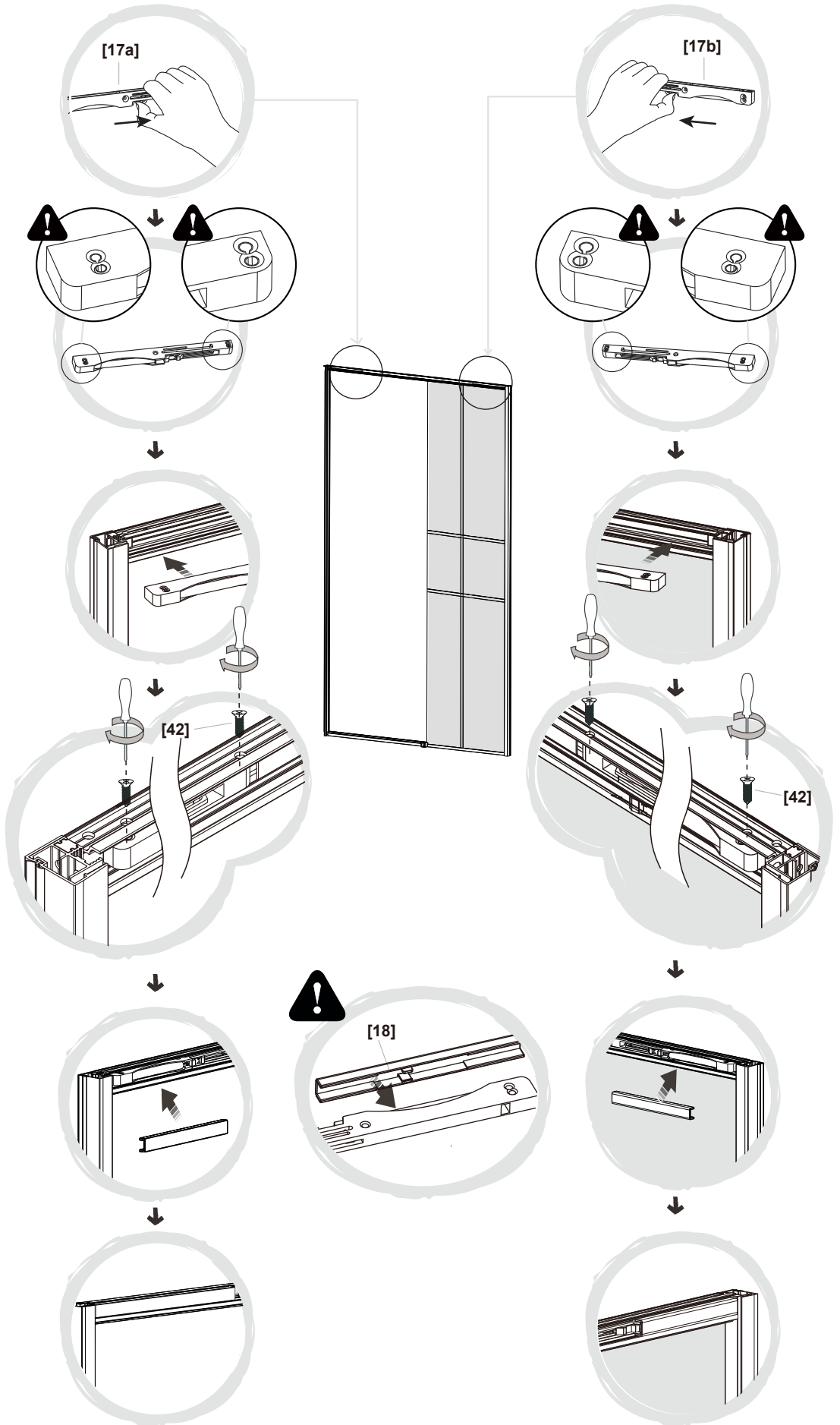



EN Assembly
RO Asamblare
TR Montaj

FR Assemblage
ES Montaje

PL Montaż
PT Montagem

05



[13] x 1

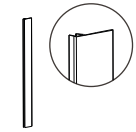

[20] x 1



[37] x 1

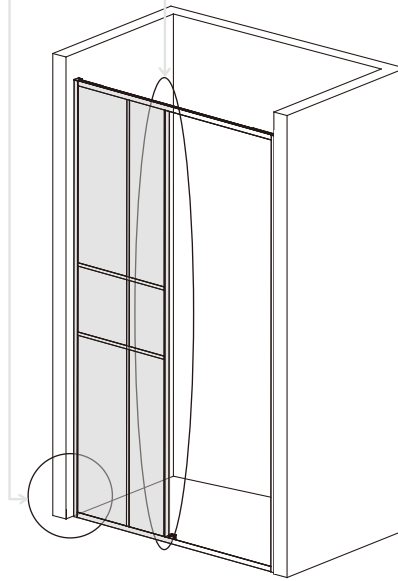
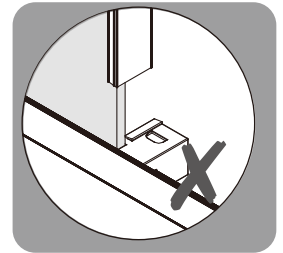
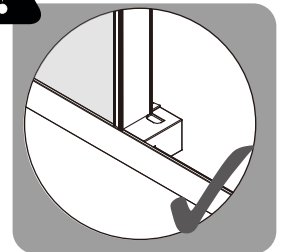
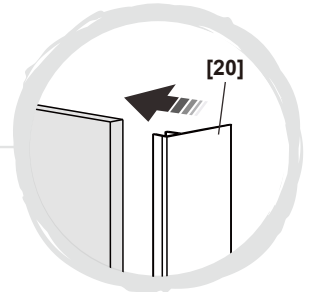
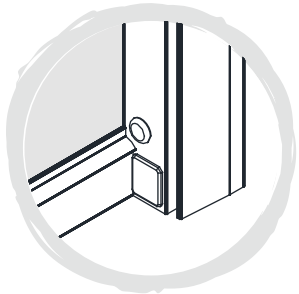
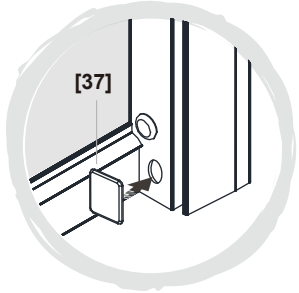
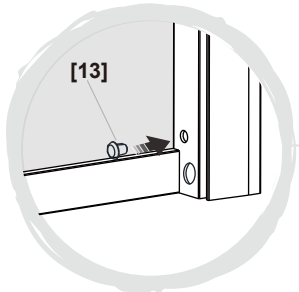



EN Assembly
RO Asamblare
TR Montaj

FR Assemblage
ES Montaje

PL Montaż
PT Montagem

06

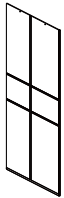

[05] x 1

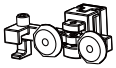

[16a] x 1

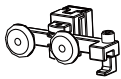

[16b] x 1



[48] x 1

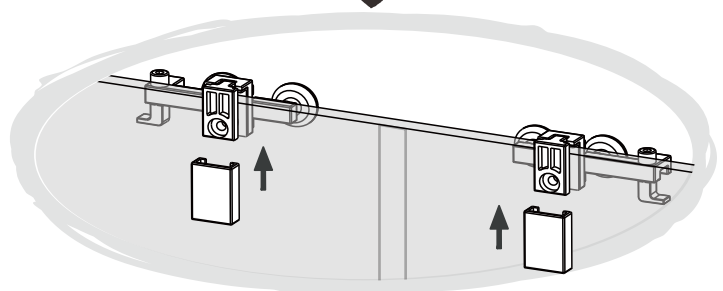
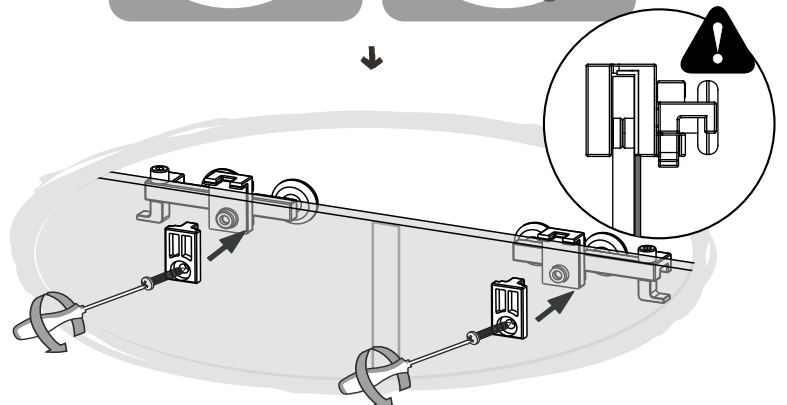
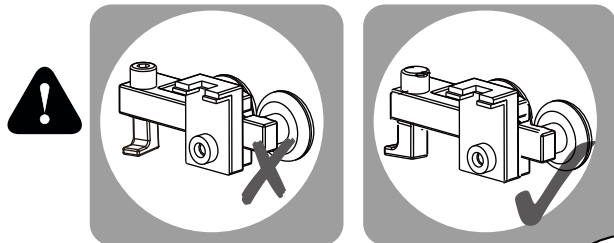
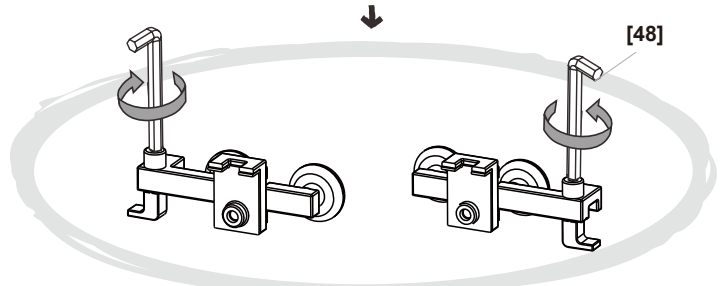
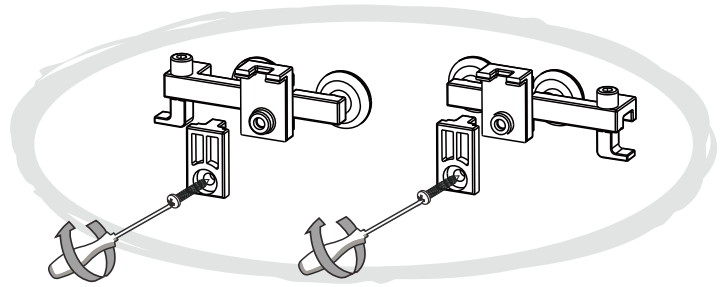
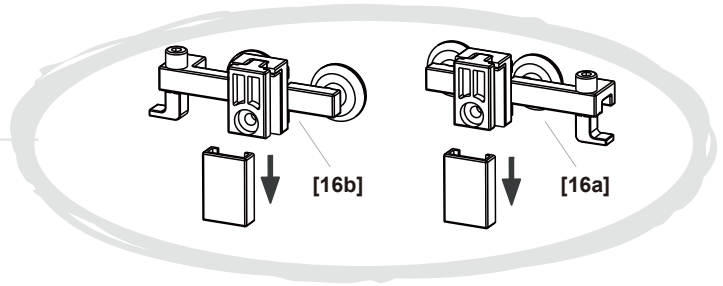
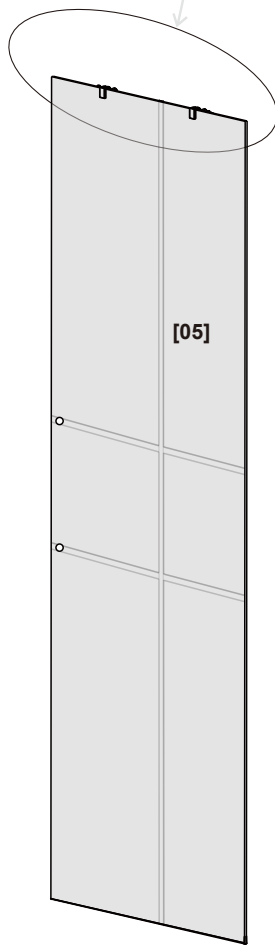



EN Assembly
RO Asamblare
TR Montaj

FR Assemblage
ES Montaje

PL Montaż
PT Montagem

07



[14] x 1



[28] x 1

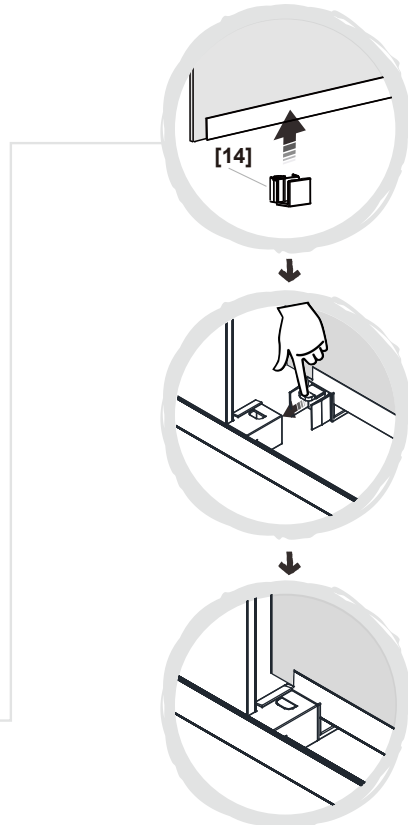
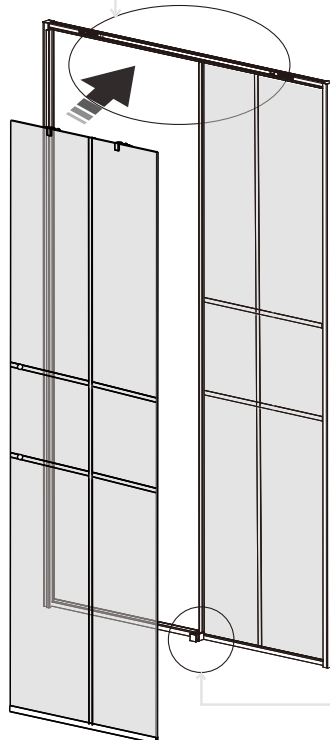
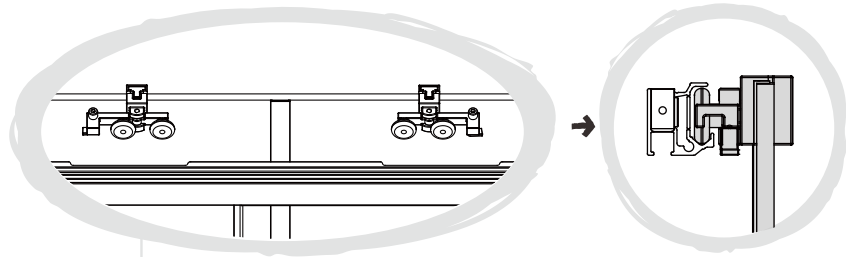
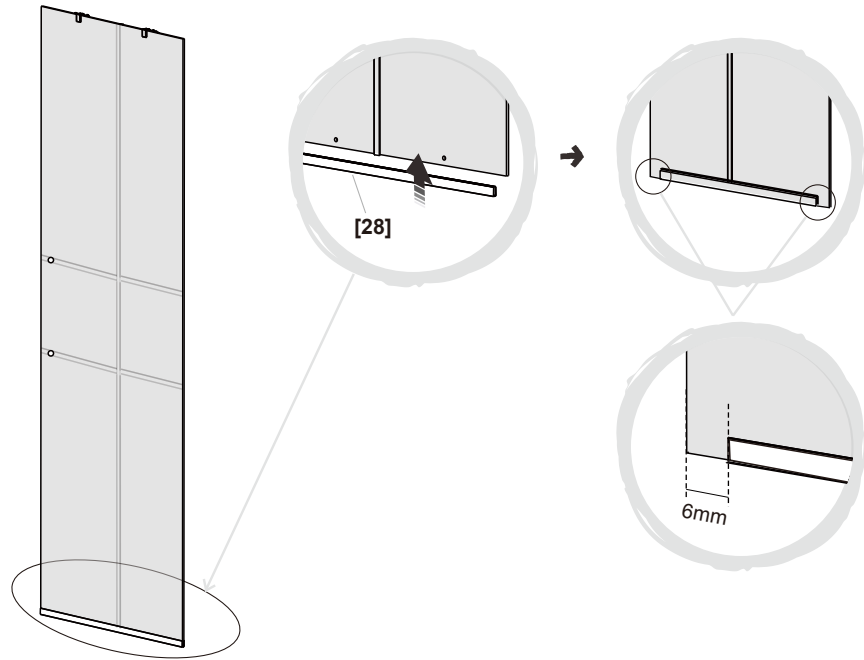



EN Assembly
RO Asamblare
TR Montaj

FR Assemblage
ES Montaje

PL Montaż
PT Montagem

08

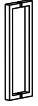

[19] x 1



[48] x 1

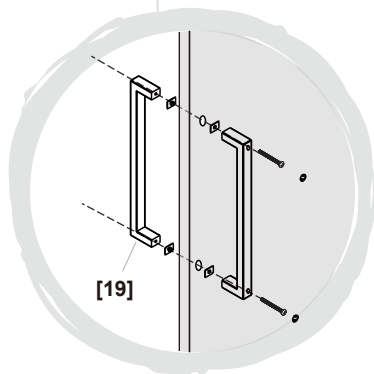
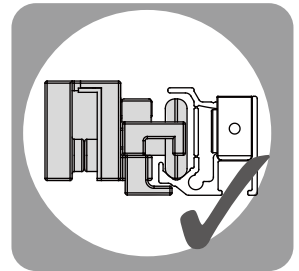
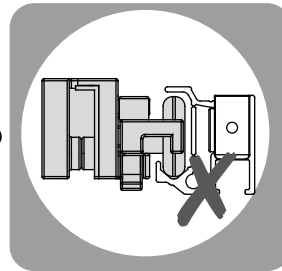
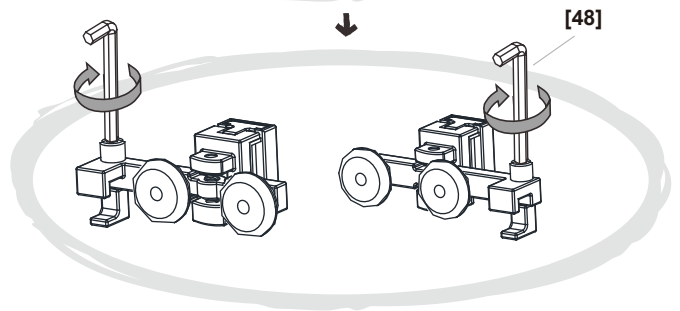
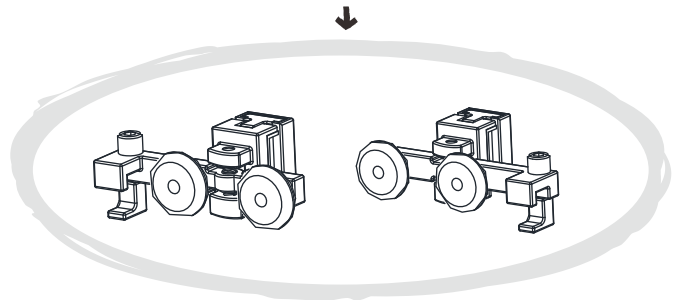
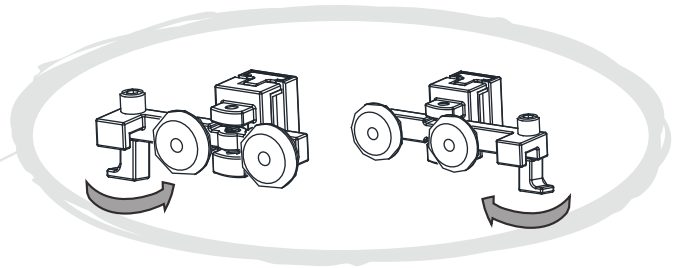
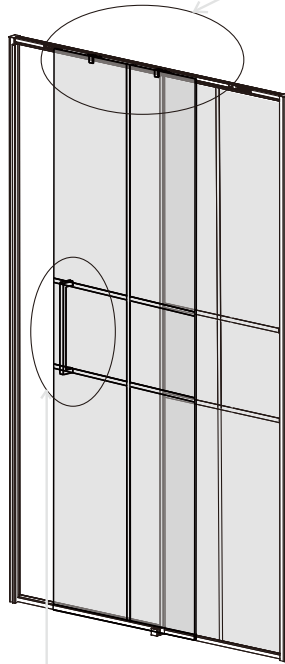



09



[24] x 2

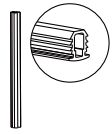

[26] x 1



[34] x 1

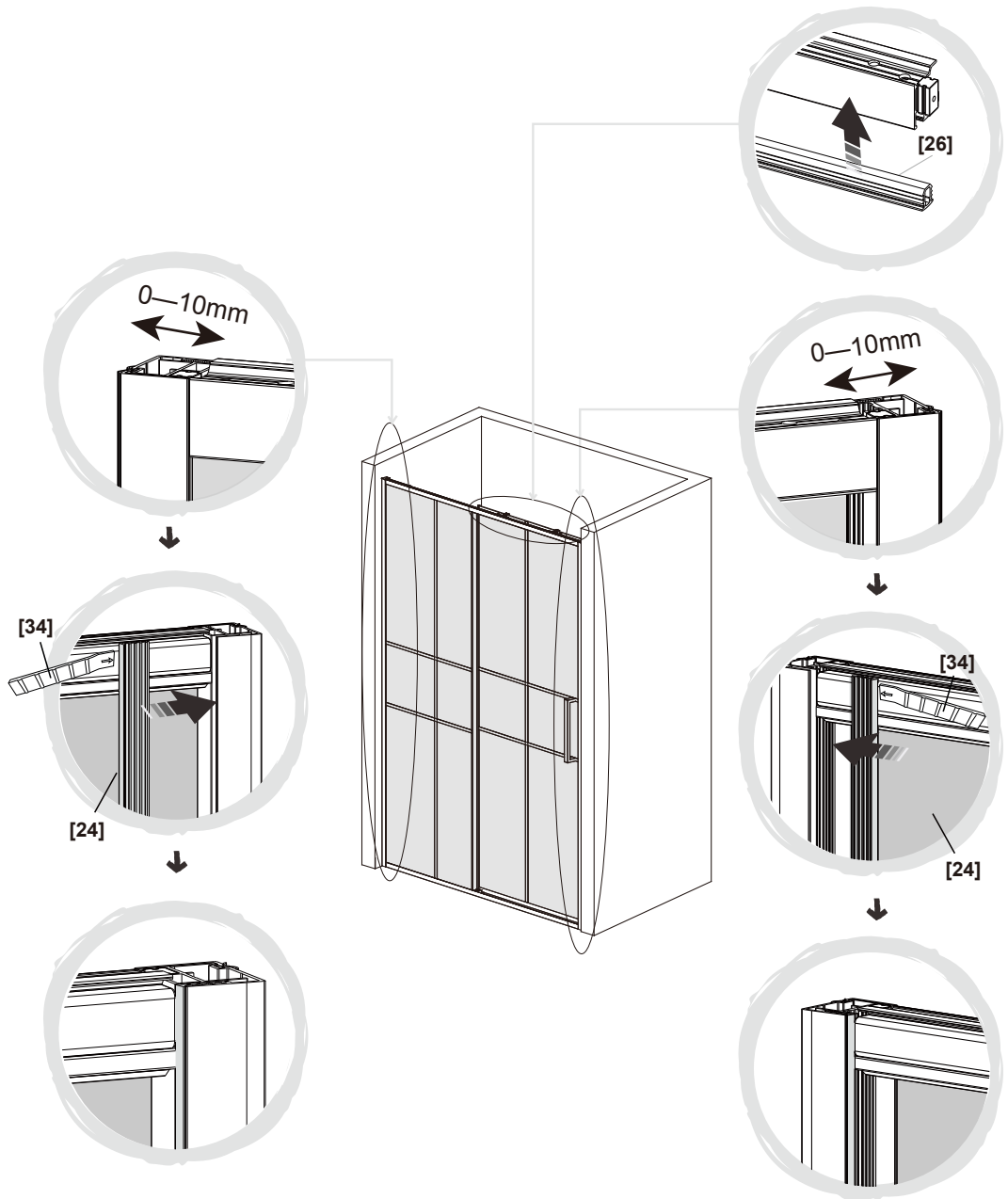



EN Assembly
 RO Asamblare
 TR Montaj

FR Assemblage
 ES Montaje

PL Montaż
 PT Montagem

10

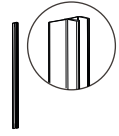

[21] x 1

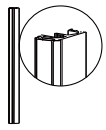

[22] x 1



[23] x 1

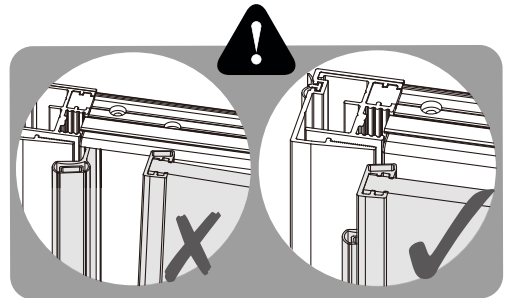
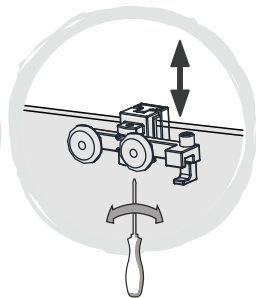
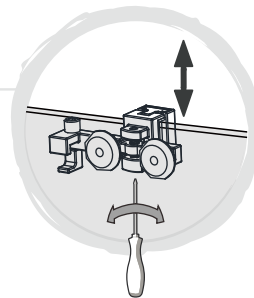
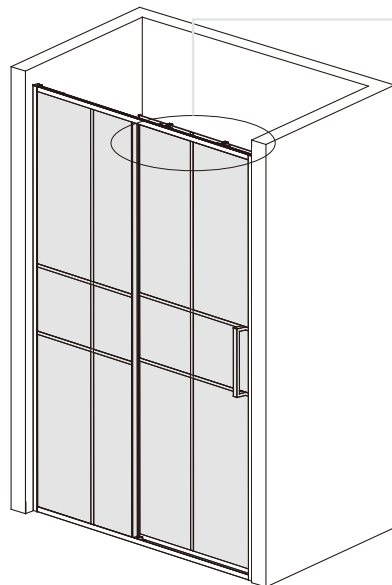
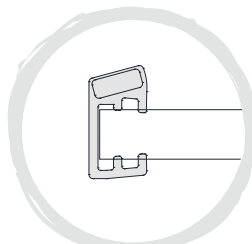
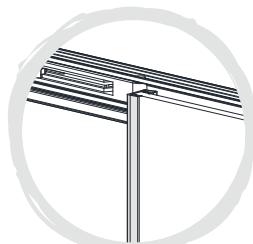
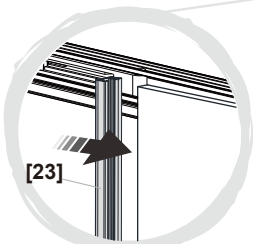
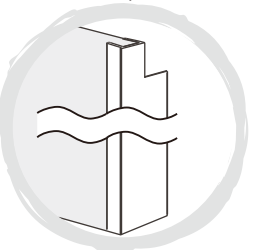
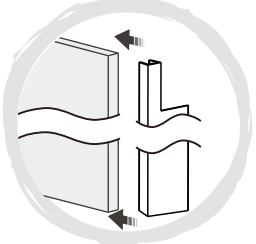
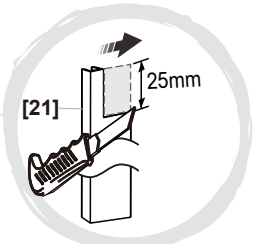
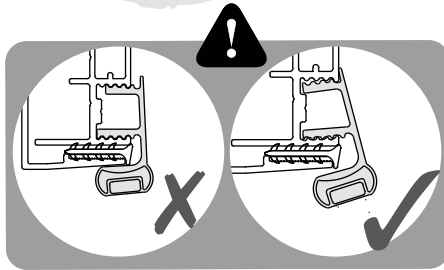
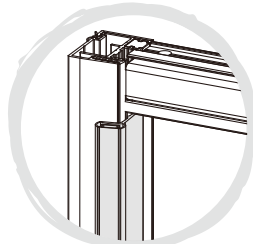



EN Assembly
RO Asamblare
TR Montaj

FR Assemblage
ES Montaje

PL Montaż
PT Montagem

11

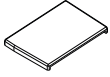

[38a] x 1

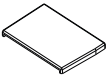

[38b] x 1

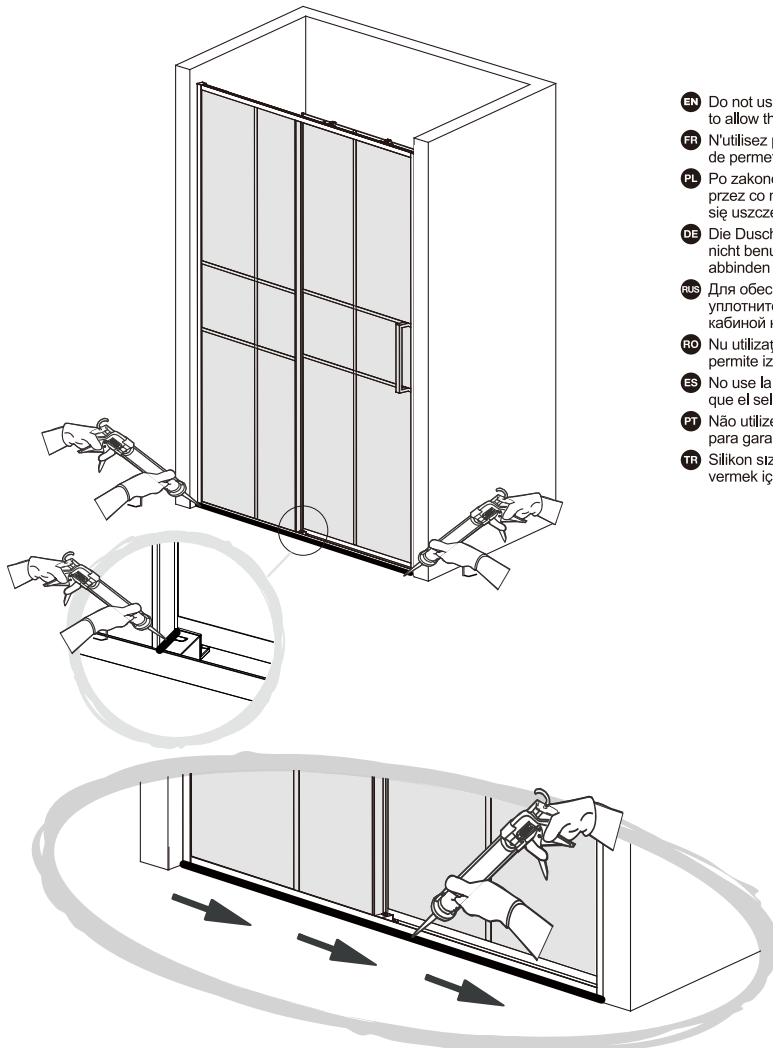
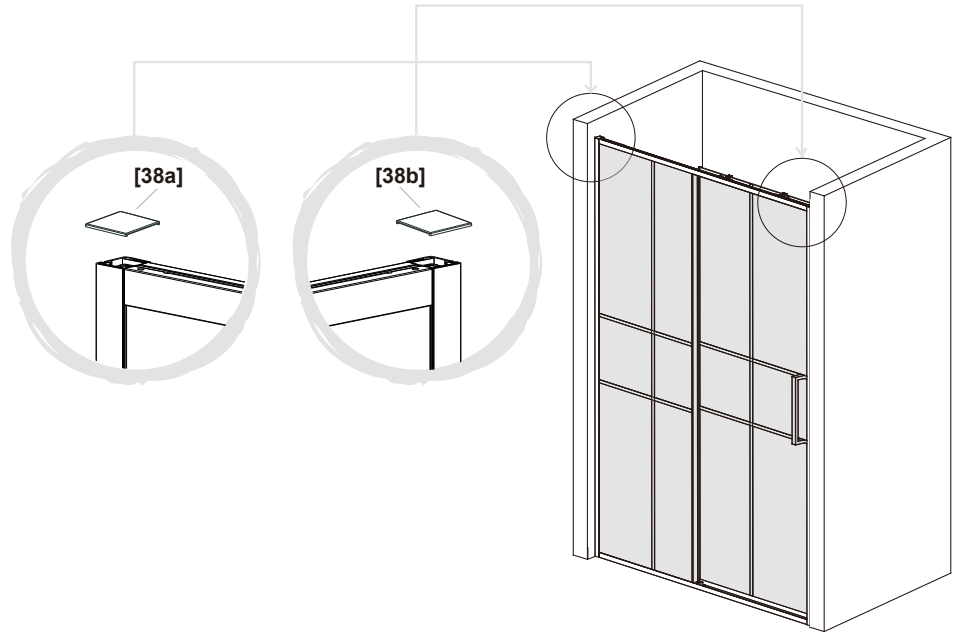

- EN Do not use the shower enclosure for at least 24 hours in order to allow the silicone sealant to cure fully.
- FR N'utilisez pas votre douche pendant au moins 24 heures afin de permettre aux joints de silicone de sécher entièrement.
- PL Po zakończonym montażu, nie używaj brodzika prysznicowego przez co najmniej 24 godziny, aby umożliwić pełne osadzenie się uszczelniacza silikonowego.
- DE Die Duschkabine darf innerhalb von mindestens 24 Stunden nicht benutzt werden, damit die Silikonversiegelung vollständig abbilden kann.
- RUS Для обеспечения полного высыхания силиконового уплотнителя воздержитесь от пользования душевой кабиной на протяжении 24 часов после установки.
- RO Nu utilizați cabina de duș timp de cel puțin 24 de ore pentru a permite izolației de silicon să se usuce complet.
- ES No use la cabina de la ducha por lo menos 24 horas para dejar que el sellador de silicon se fragüe completamente.
- PT Não utilize a divisória de chuveiro durante, no mínimo, 24 horas para garantir que o vedante de silicone fica totalmente seco.
- TR Silikon sızdırmazlık malzemesinin tamamen kurumasına izin vermek için duşakabini en az 24 saat boyunca kullanmayın.





01

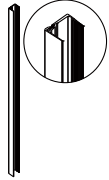

[01] x 1



[36] x 6



St4x30mm

[46] x 3



- EN** Note: Ensure that the sides of the glass panels with the Easy Clean treatment logo on are positioned facing inward.
FR Remarque : Assurez-vous que les faces des panneaux en verre avec le logo nettoyage facile sont positionnées face vers l'intérieur.
PL Informacja: Upewnij się, że obie strony szyb pokrytych powłoką "Easy Clean" są skierowane do wewnątrz.
DE Hinweis: Vergewissern Sie sich, dass die Seiten der Glasscheiben mit der Easy Clean-Behandlung an der Wandseite nach innen zeigen.
RU Примечание. Убедитесь, что стороны стеклянных панелей со специальной обработкой для легкой очистки ориентированы внутрь.
RO Notă: Asigurați-vă că panourile de sticlă cu fațada tratată cu Easy Clean sunt poziționate înspre interiorul cabinei.
ES Nota: Asegúrese que los paneles de vidrio con tratamiento de Easy Clean estén colocados hacia el interior.
PT Note: Nota: Certifique-se de que os lados dos painéis de vidro com o tratamento Easy Clean estão voltados para dentro.
TR Not: Cam panellerin, üzerinde Kolay Temizlik uygulaması bulunan yüzeyinin içe doğru bakacak şekilde konulmuş olduğundan emin olun.

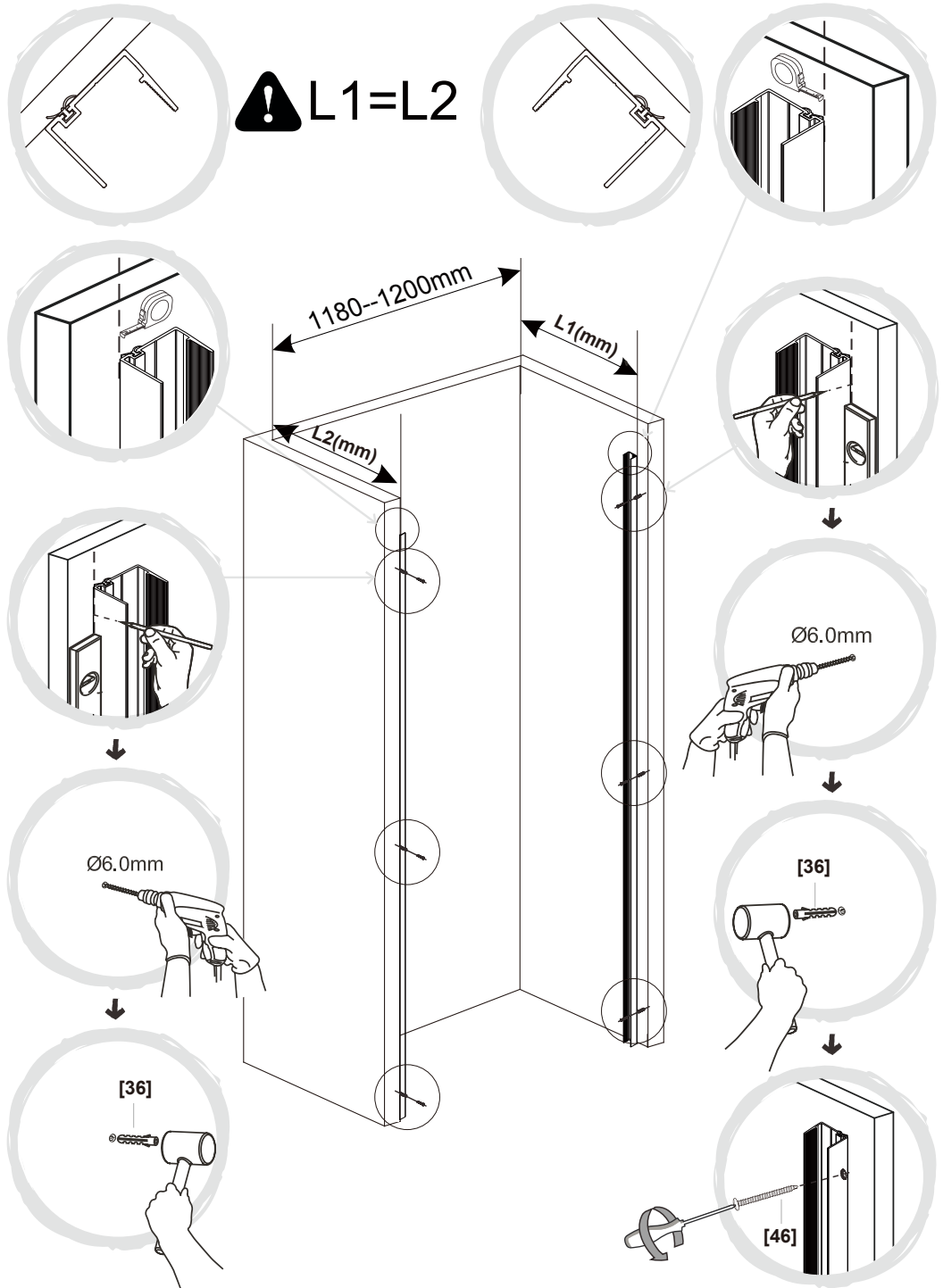



02

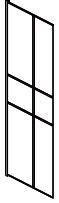

[04] x 1

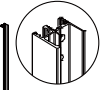

[08] x 1



[09] x 1

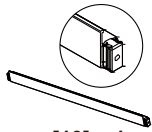

[10] x 1



[15b] x 1

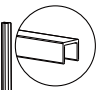

[25] x 1

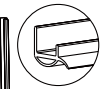

[27b] x 1

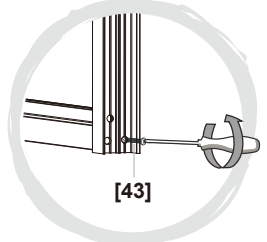
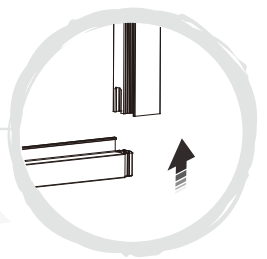
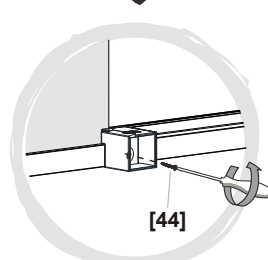
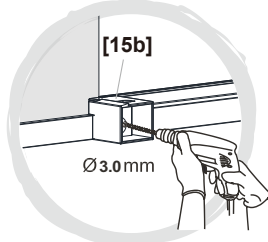
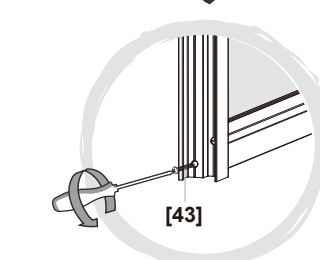
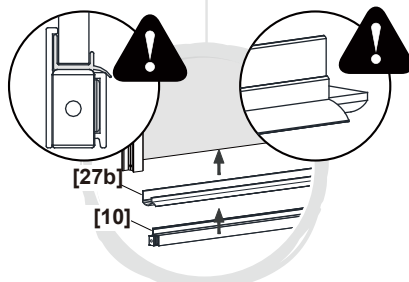
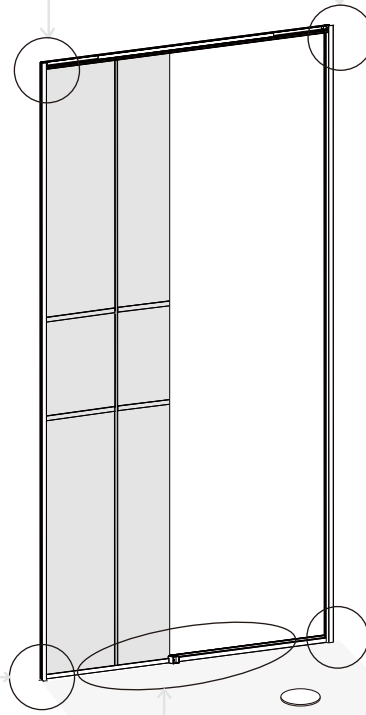
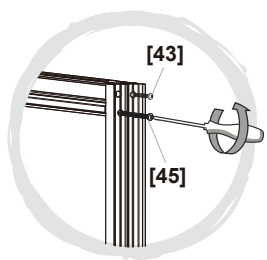
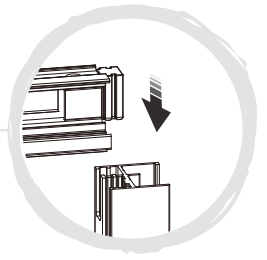
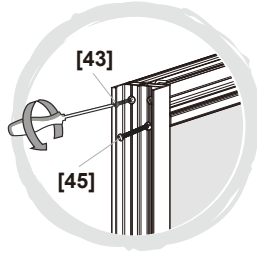
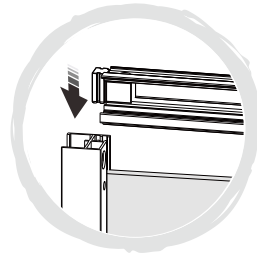
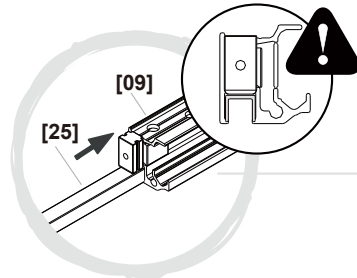



EN Assembly
RO Asamblare
TR Montaj

FR Assemblage
ES Montaje

PL Montaż
PT Montagem

03

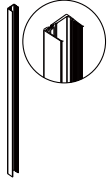

[01] x 1



St4x30mm

[46] x 3

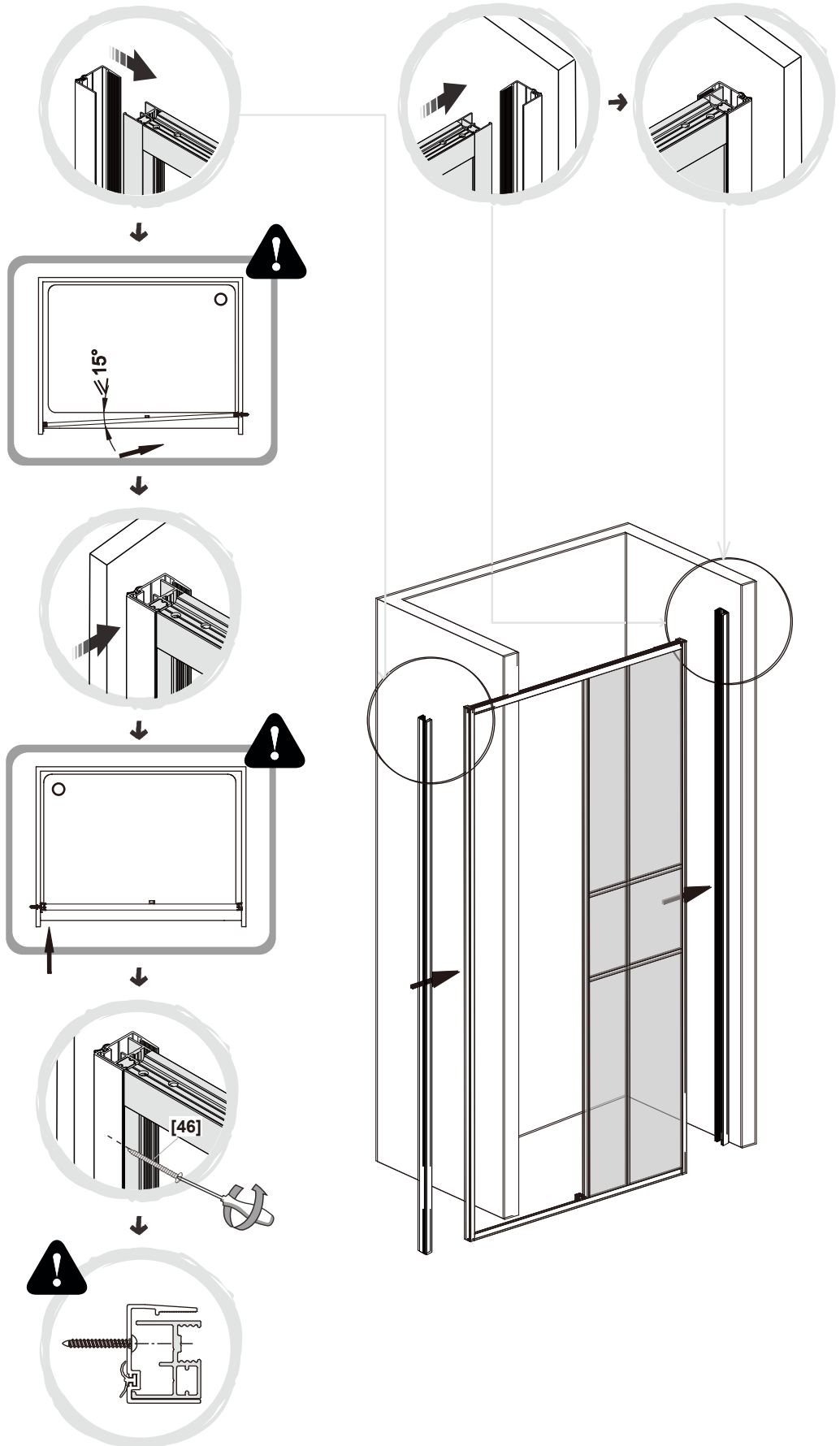



EN Assembly
 RO Asamblare
 TR Montaj

FR Assemblage
 ES Montaje

PL Montaż
 PT Montagem

04



[17a] x 1



[17b] x 1



[18] x 2



S4x10mm

[42] x 4

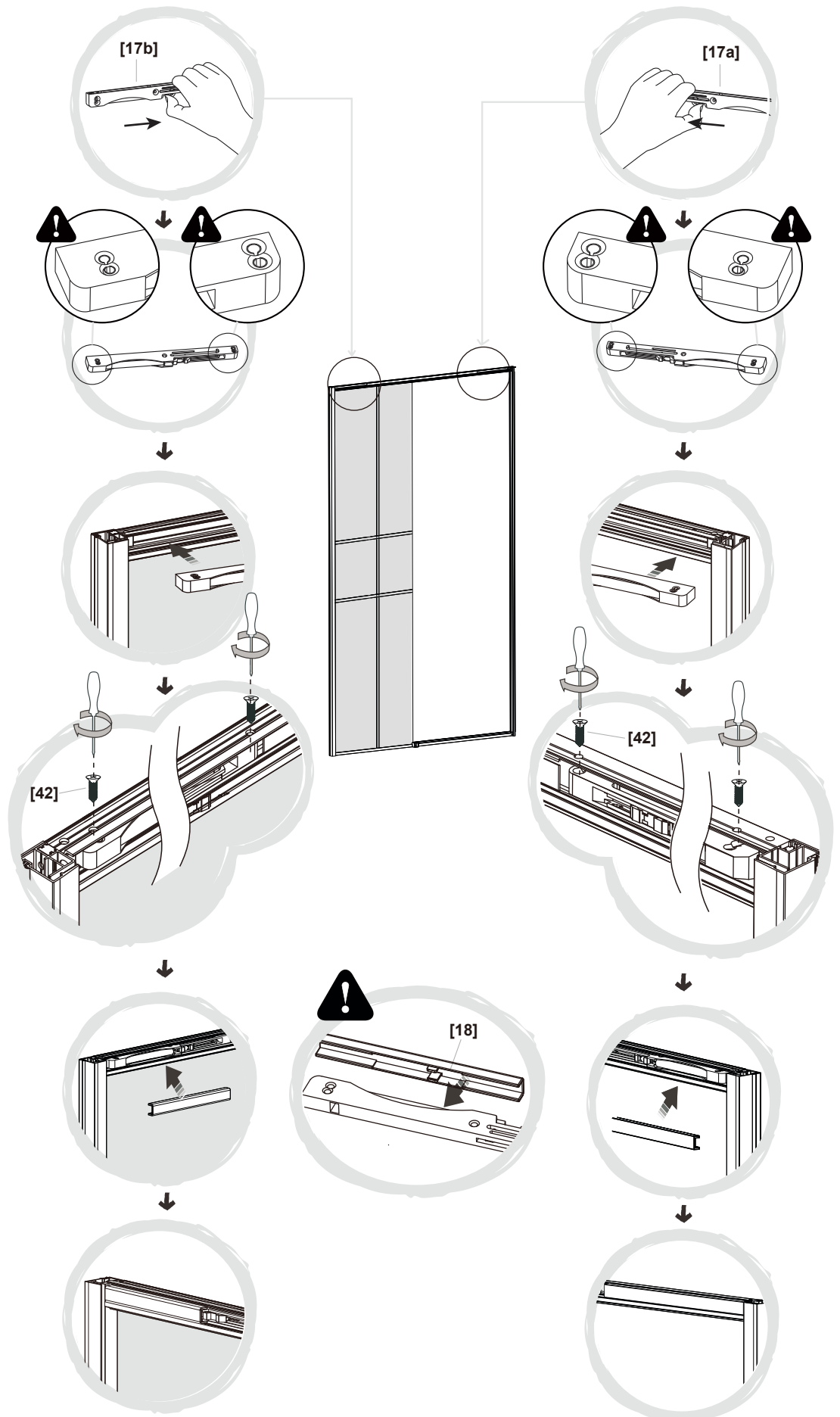



EN Assembly
RO Asamblare
TR Montaj

FR Assemblage
ES Montaje

PL Montaż
PT Montagem

05



[13] x 1

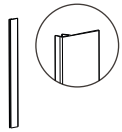

[20] x 1



[37] x 1

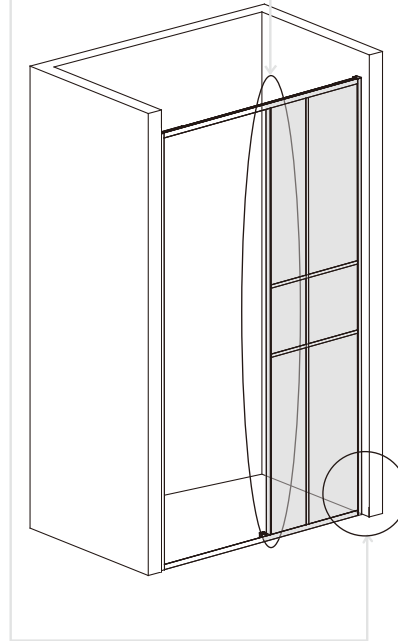
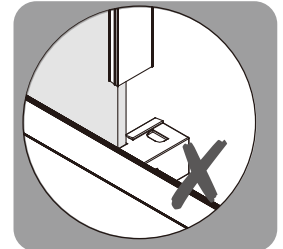
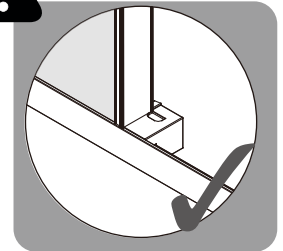
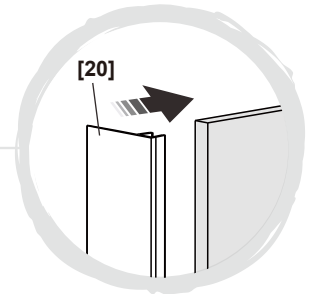
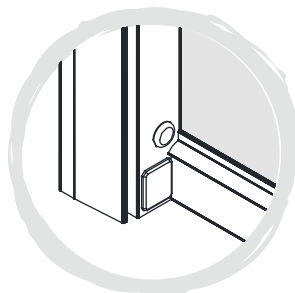
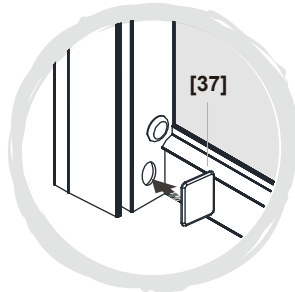
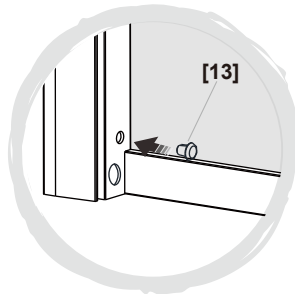



06

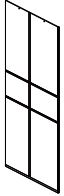

[05] x 1

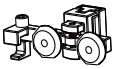

[16a] x 1

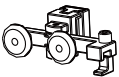

[16b] x 1



[48] x 1

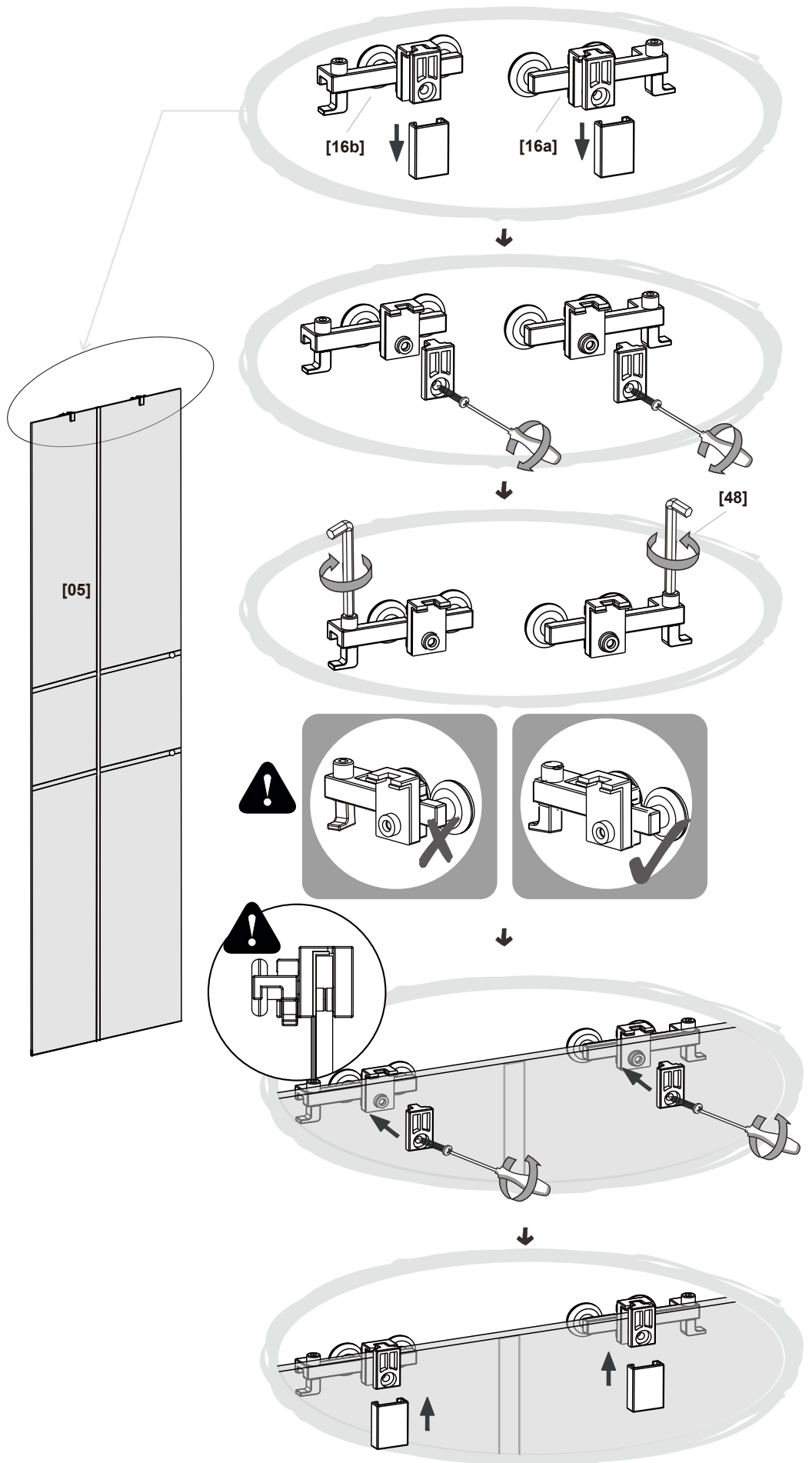



EN Assembly
RO Asamblare
TR Montaj

FR Assemblage
ES Montaje

PL Montaż
PT Montagem

07



[14] x 1



[28] x 1

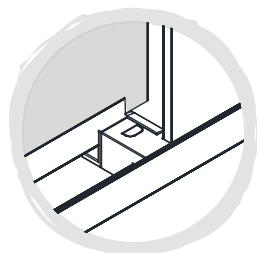
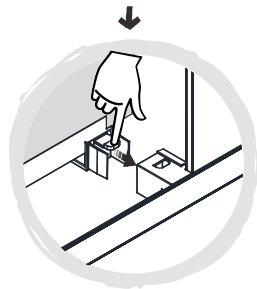
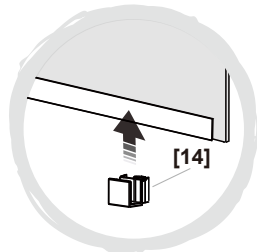
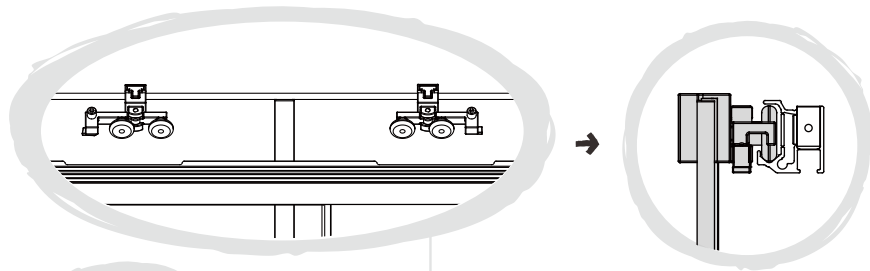
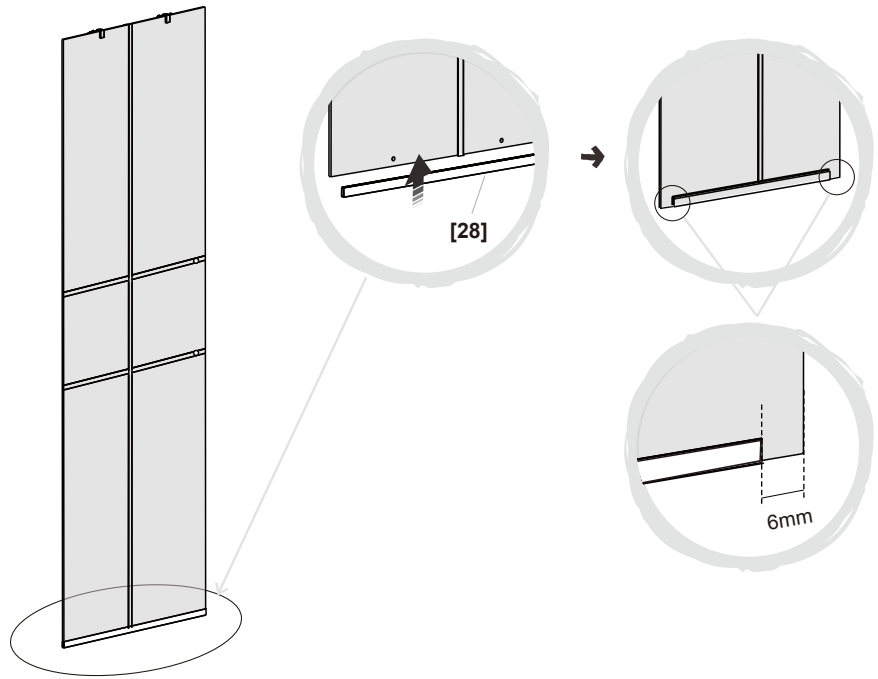



EN Assembly
RO Asamblare
TR Montaj

FR Assemblage
ES Montaje

PL Montaż
PT Montagem

08



[19] x 1



[48] x 1

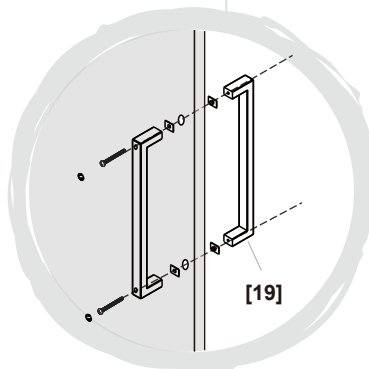
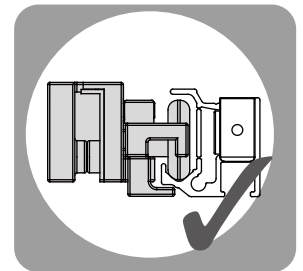
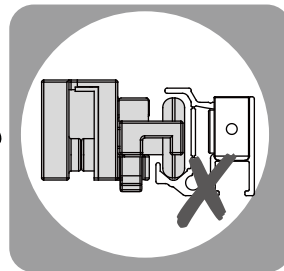
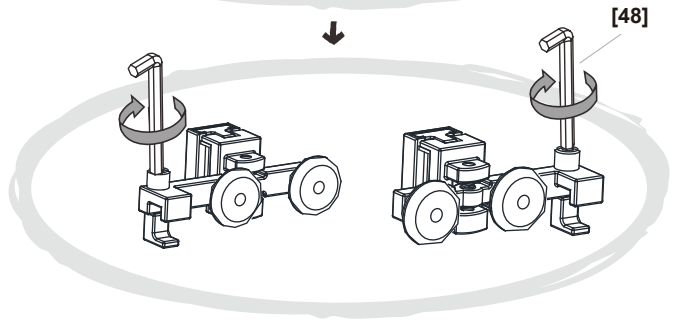
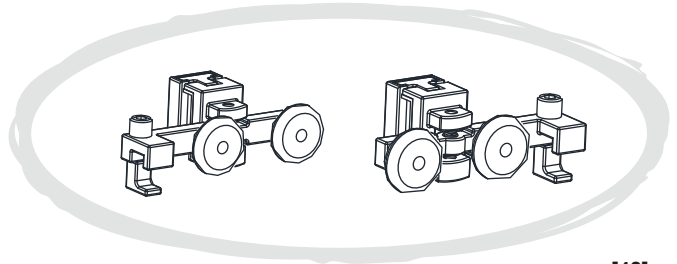
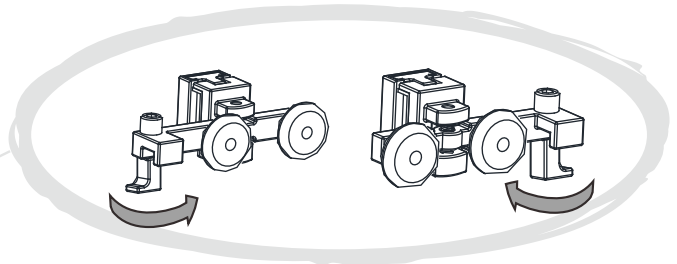
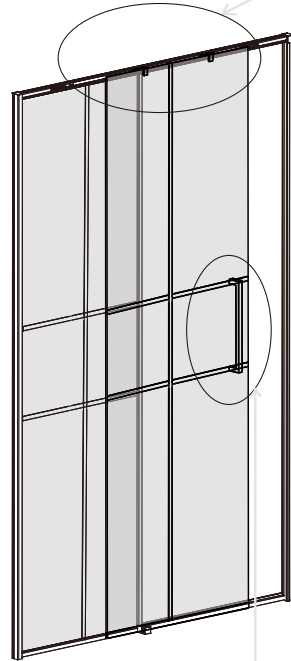



09



[24] x 2

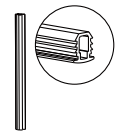

[26] x 1



[34] x 1

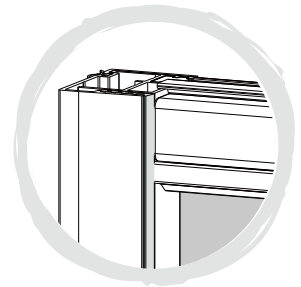
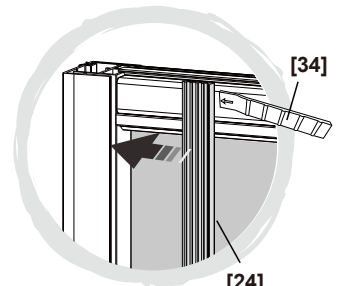
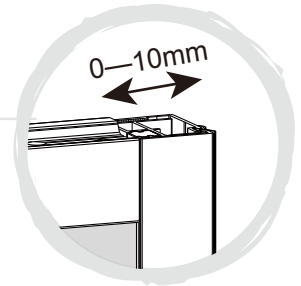
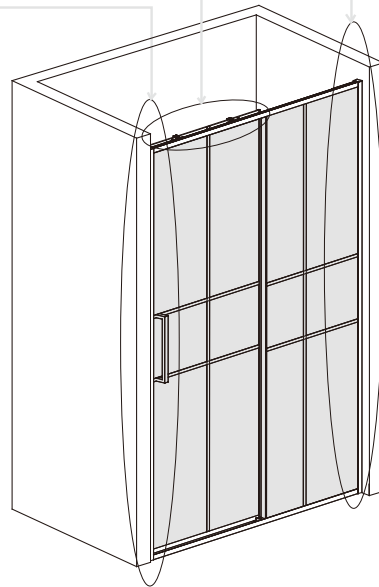
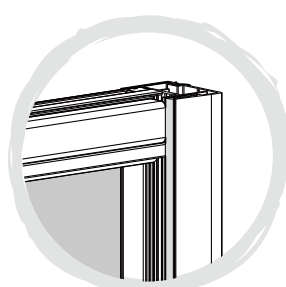
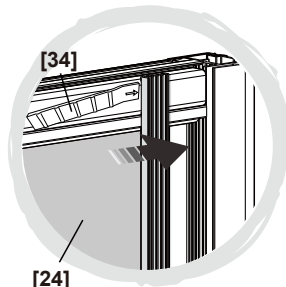
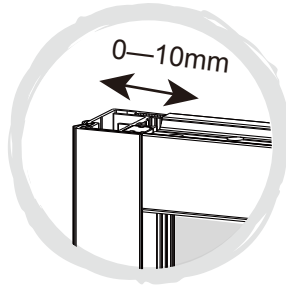
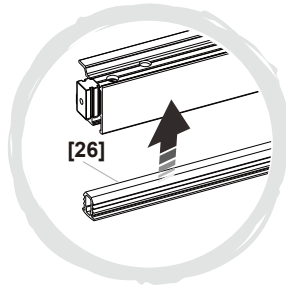



10



[21] x 1

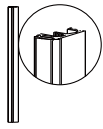

[22] x 1

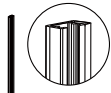

[23] x 1

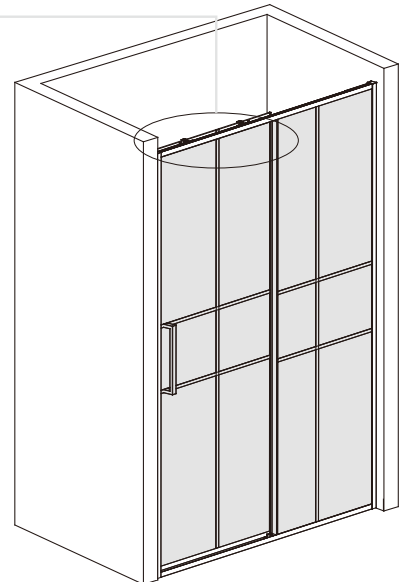
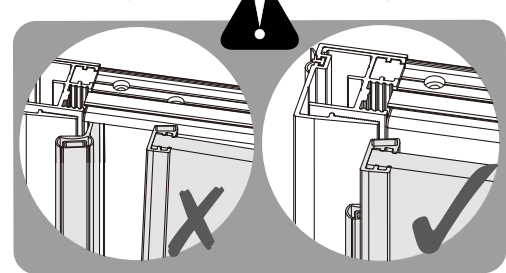
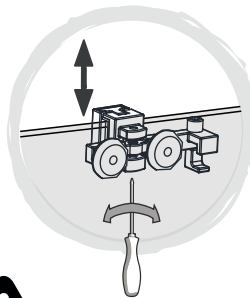
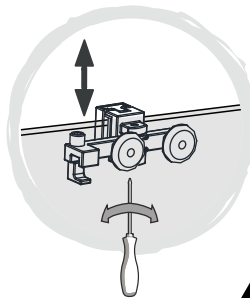
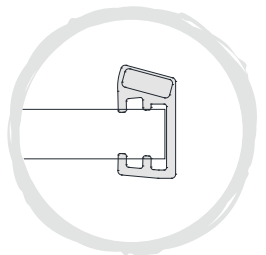
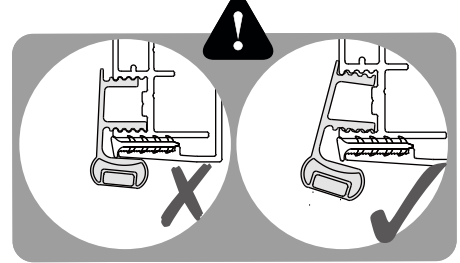
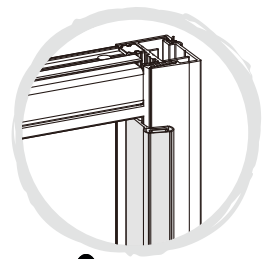
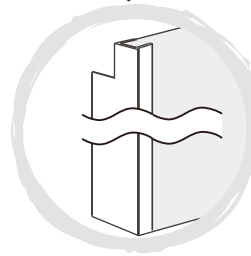
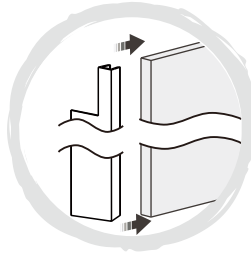
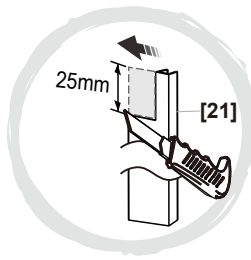



EN Assembly
RO Asamblare
TR Montaj

FR Assemblage
ES Montaje

PL Montaż
PT Montagem

11

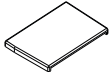

[38a] x 1

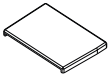

[38b] x 1

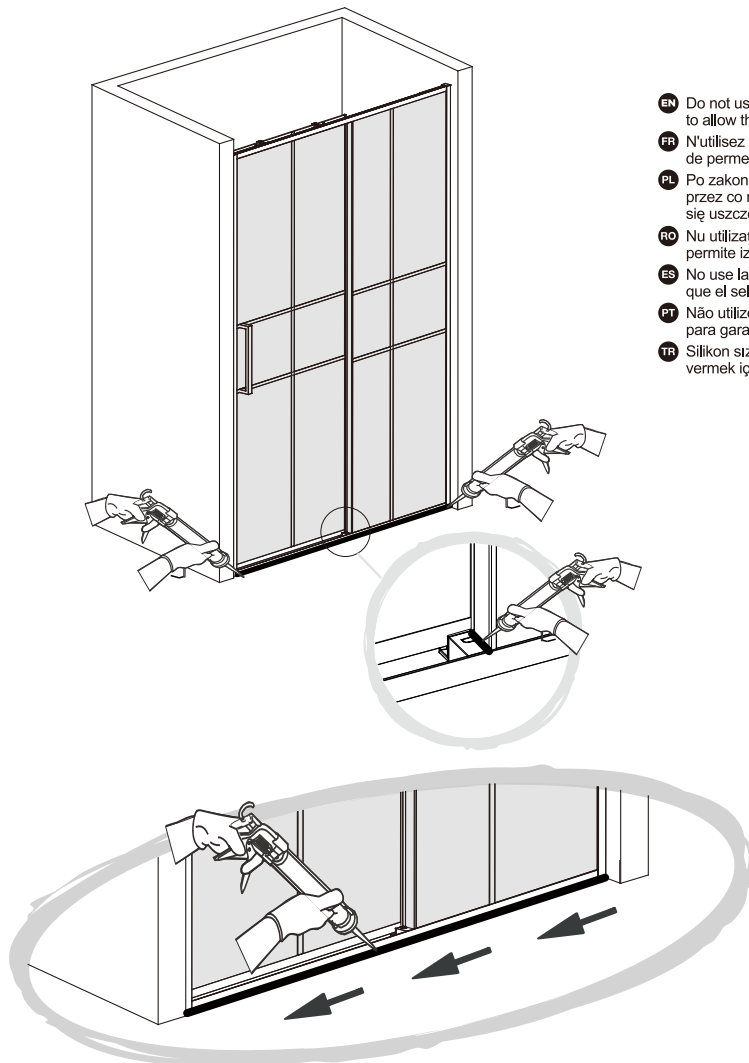
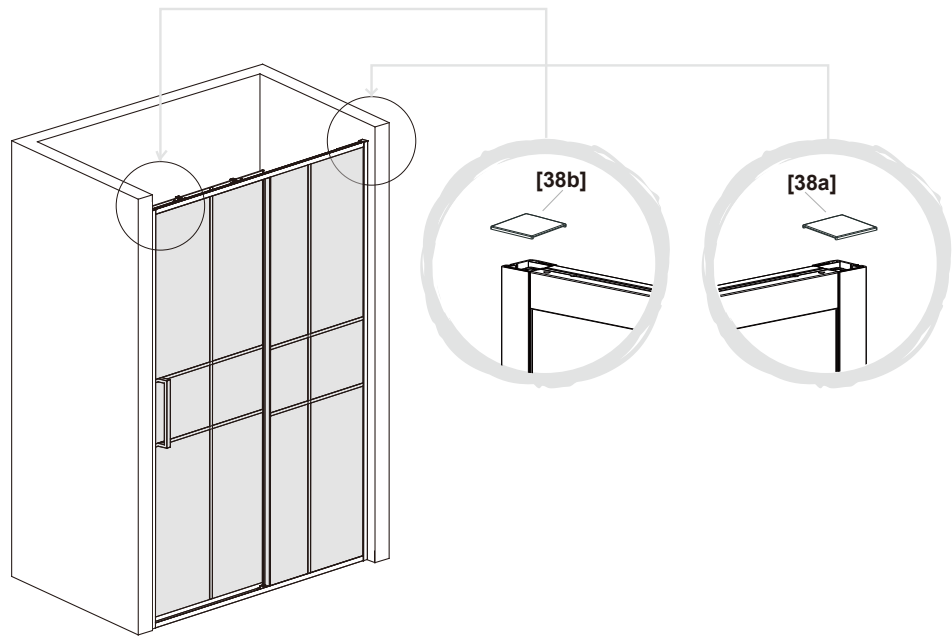

- EN Do not use the shower enclosure for at least 24 hours in order to allow the silicone sealant to cure fully.
- FR N'utilisez pas votre douche pendant au moins 24 heures afin de permettre aux joints de silicone de sécher entièrement.
- PL Po zakończonym montażu, nie używaj brodzika prysznicowego przez co najmniej 24 godziny, aby umożliwić pełne osadzenie się uszczelnacza silikonowego.
- RO Nu utilizați cabina de duș timp de cel puțin 24 de ore pentru a permite izolației de silicon să se usuce complet.
- ES No use la cabina de la ducha por lo menos 24 horas para dejar que el sellador de silicon fragüe completamente.
- PT Não utilize a divisória de chuveiro durante, no mínimo, 24 horas para garantir que o vedante de silicone fica totalmente seco.
- TR Silikon sızdırmazlık malzemesinin tamamen kurumasına izin vermek için duşakabini en az 24 saat boyunca kullanmayın.





EN Care and Maintenance
RO Îngrijire și întreținere
TR Bakım ve Onarım

FR Entretien et Maintenance PL Czystczenie i konserwacja
ES Cuidados y Mantenimiento PT Cuidados e Manutenção

EN

NOTE: Use warm soapy water and a soft damp cloth to keep the glass clean. Wipe dry with a clean cloth. Scourers, abrasives and chemical cleaners can damage the glass and pattern, and should not be used. In hard water areas, insoluble lime salts may be deposited on the glass. If this is allowed to build up it becomes increasingly difficult to remove and looks unsightly. Regular cleaning will minimize this effect.

- Do not attempt to cut the glass.
- Do not strike the glass with hard or pointed items.
- Regularly check moving parts such as rollers and hinges to ensure they are secure and adjusted correctly. Tighten and adjust where required. Also check all sealed joints to ensure seal has not deteriorated. Re-seal if required.

FR

REMARQUE : Utilisez de l'eau tiède savonneuse et un chiffon doux humide pour garder la vitre propre. Si nécessaire, vous pouvez utiliser un produit pour vitres. Grattoirs, abrasifs et nettoyeurs chimiques peuvent endommager la vitre et le motif, et ne doivent ainsi pas être utilisés.

Dans les zones dont l'eau est dure, un dépôt de calcaire peut se former sur la vitre. Si vous le laissez s'accumuler, il deviendra de plus en plus difficile à enlever, et sera inesthétique. Un nettoyage régulier permet de réduire cet effet.

- Ne tentez pas de découper la vitre.
- Ne cognez pas la vitre avec des objets durs ou pointus.
- Vérifiez régulièrement les pièces mobiles telles que les rouleaux et charnières afin de vous assurer qu'elles sont solidement fixées et correctement réglées. Serrez et ajustez-les lorsque nécessaire. Vérifiez également tous les joints scellés afin de vous assurer de l'intégrité de l'étanchéité. Scellez à nouveau au besoin.

PL

INFORMACJA: Użyj szmatki z ciepłą mydlaną wodą do czyszczenia szyby. Nie należy używać do czyszczenia ostrych zmywaków oraz szorujących lub chemicznych środków czyszczących, ponieważ mogą one uszkodzić szklaną powierzchnię lub wzór na szkle.

W twardej wodzie, nierozpuszczalne sole wapna mogą odkładać się na szybie. Jeśli nagromadzi się ich duża ilość, wówczas stają się one bardzo trudne do usunięcia. Regularne czyszczenie zminimalizuje ten efekt.

- Nie przecinaj szyb.
- Nie uderzaj w szyby twardymi lub spiczastymi przedmiotami.
- Regularnie sprawdzaj ruchome części, takie jak rolki i zawiasy, aby upewnić się, że są one bezpieczne i właściwie ustawione. Dokręć i wyreguluj je w razie potrzeby. Dodatkowo sprawdzaj wszystkie uszczelnione złącza, aby upewnić się, że uszczelnienie nie uległo pogorszeniu. Ponownie uszczelnij w razie potrzeby.

RO

NOTA: Utilizați apă caldută cu detergent și o cârpă moale pentru a menține geamul curat. Uscați ștergând cu o cârpă curată. Bureții abrazivi, produsele de curățat abrazive și chimice pot avaria sticla și aspectul acesteia, și nu ar trebui utilizate.

În zone cu apă dură, săruri insolubile de calcar se pot acumula pe sticlă. Dacă acestea sunt lăsate să se depoziteze, aceste acumulări pot deveni extrem de greu de îndepărtat și vor arăta neaspectuos. Curățarea periodică va minimiza acest efect.

- Nu încercați să tăiați sticla.
- Nu loviți sticla cu articole ascuțite sau dure.
- Verificați periodic piesele mobile precum roțile și balmalele pentru a vă asigura că sunt sigure și reglate corect. Strângeți și ajustați unde este nevoie. De asemenea verificați toate izolațiile de etanșeizare pentru a vă asigura că nu sunt deteriorate. Reizolați dacă este nevoie.

ES

NOTA: Use agua jabonosa tibia y un trapo húmedo suave para mantener el vidrio limpio. Seque con un trapo limpio. Las fibras, los limpiadores abrasivos y los químicos pueden dañar el vidrio y el dibujo, por lo que no deben usarse.

En zonas de agua dura, las sales insolubles de cal pueden depositarse en el vidrio. Si se permite que se acumulen será cada vez más difícil retirarlas y se verá desagradable. La limpieza regular minimizará este efecto.

- No intente cortar el vidrio.
- No golpee el vidrio con artículos duros o puntiagudos.
- Compruebe con regularidad las partes móviles, como las ruedas y bisagras, para asegurarse de que están correctamente ajustadas. Apriételas y ajústelas cuando sea necesario. Compruebe también las juntas selladas para asegurarse de que el sellado no se ha deteriorado. Vuelva a sellarlo si fuera necesario.

PT

NOTA: Utilize água morna com sabão e um pano macio húmido para manter o vidro limpo. Limpe com um pano seco. Esfregões, substâncias abrasivas e substâncias químicas podem danificar o vidro e o padrão e não devem ser utilizados.

Em zonas de água calcária, poderão depositar-se resíduos insolúveis no vidro. Se se forem acumulando, torna-se cada vez mais difícil removê-los e o vidro torna-se inestético. Uma limpeza regular minimiza este efeito.

- Não tente cortar o vidro.
- Não bata no vidro com objetos rígidos ou pontiagudos.
- Verifique regularmente as peças móveis, como os roletes e as dobradiças, para garantir que estão devidamente fixos e ajustados. Aperte e ajuste sempre que necessário. Verifique igualmente se as uniões vedadas não apresentam sinais de deterioração. Vede novamente, se necessário.

TR

NOT: Camı temiz tutmak için ılık sabunlu su ve yumuşak nemli bir bez kullanın. Temiz bir bezle kurulayın. Çözücüler, aşındırıcılar ve kimyasal temizleyiciler cama ve dokusuna zarar vereceğinden kullanılmamalıdır.

Suyu sert olan bölgelerde, çözünmeyen kireç tuzları camın üzerinde birikebilir. Bunun birikmesine izin verilirse çıkarılması giderek daha zor bir hal alır ve göze hoş görünmez. Düzenli temizlik bu etkiyi azaltır.

- Camı kesmeye çalışmayın.
- Cama sert veya sivri uçlu nesnelere vurmayın.
- Makara ve mafsal gibi hareketli parçaları düzenli olarak kontrol ederek sağlam ve ayarlarının doğru olduğundan emin olun. Gerektiğinde sıkın ve ayarlayın. Ayrıca contada çürüme, bozulma olmadığından emin olmak için tüm sızdırmazlık noktalarını kontrol edin. Gerekirse sızdırmazlığı yeniden sağlayın.

Manufacturer • Fabricant • Producent

Producător • Fabricante:

UK Manufacturer:

Kingfisher International Products Limited,
3 Sheldon Square, London, W2 6PX,
United Kingdom

EU Manufacturer:

Kingfisher International Products B.V.
Rapenburgerstraat 175E
1011 VM Amsterdam
The Netherlands
www.kingfisher.com/products

EN

www.diy.com
www.screwfix.com
www.screwfix.ie

**To view instruction manuals online,
visit www.kingfisher.com/products**

FR

www.castorama.fr
www.bricodepot.fr

**Pour consulter les manuels d'instructions
en ligne, rendez-vous sur le site
www.kingfisher.com/products**

PL

www.castorama.pl

**Aby zapoznać się z instrukcją obsługi online,
odwiedź stronę www.kingfisher.com/products**

RO

bricodepot.ro

**Pentru a consulta manualele de instrucțiuni
online, vizitați www.kingfisher.com/products**

ES

www.bricodepot.es

**Para consultar los manuales de instrucciones
en línea, visite www.kingfisher.com/products**

PT

www.bricodepot.pt

**Para consultar manuais de instruções online,
visite www.kingfisher.com/products**

TR

İthalatçı Firma:

KOÇTAŞ YAPI MARKETLERİ TİC. A.Ş.
Taşdelen Mah. Sırrı Çelik Bulvarı No:5
34788 Taşdelen/Çekmeköy/İSTANBUL
Tel: +90 216 4300300
Faks: +90 216 4844313
www.koctas.com.tr

**Kullanım kılavuzuna internet üzerinden ulaşmak
için www.kingfisher.com/products adresini
ziyaret edin**

Yetkili servis istasyonları ve yedek parça temini için
aşağıda yer alan Koçtaş Müşteri Hattı ve Koçtaş
Genel Müdürlük irtibat bilgilerinden faydalanınız.

KOÇTAŞ MÜŞTERİ HİZMETLERİ
0850 209 50 50