

Taynae

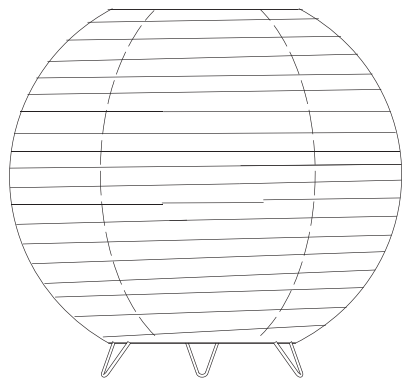

EAN: 5036581098988 / 5059340002057
 Model: KD-005-WHT

V41122_5059340002057_MAND1_2223



1 2 = **1** + **2**

<p>EN IMPORTANT - Please read carefully the separate safety guide before use.</p>	<p>FR IMPORTANT - S'il vous plaît lire attentivement le guide de sécurité séparé avant utilisation.</p>	<p>PL WAŻNE - Proszę dokładnie zapoznać się z oddzielną instrukcją bezpieczeństwa przed użyciem.</p>
<p>DE WICHTIG - Bitte lesen Sie die separaten Sicherheits Sie vor Gebrauch.</p>	<p>RO IMPORTANT - Vă rugăm să citiți cu atenție ghidul de siguranță separat înainte de utilizare.</p>	<p>TR ÖNEMLİ - Kullanımdan önce dikkatle ayrı emniyet kılavuzunu okuyun lütfen.</p>

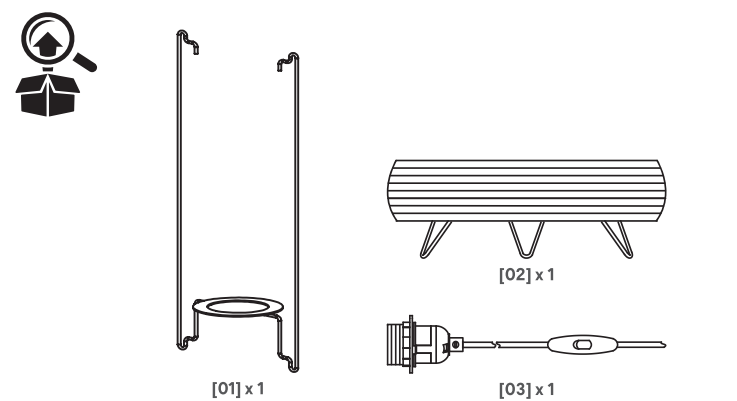

Not included

FR Non inclus
 PL Nie dołączono
 DE Nicht inbegriffen
 RO Nu este inclus
 TR Dahil değildir

E27



01

[02] x 1

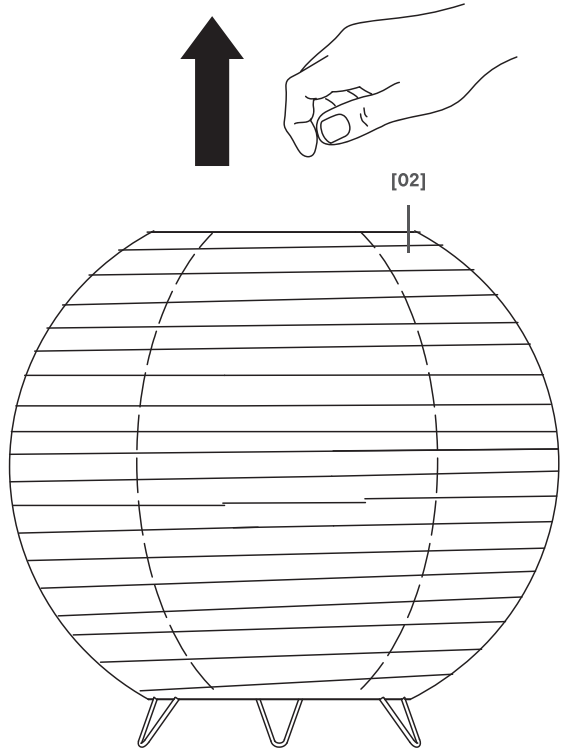

02

[01] x 1

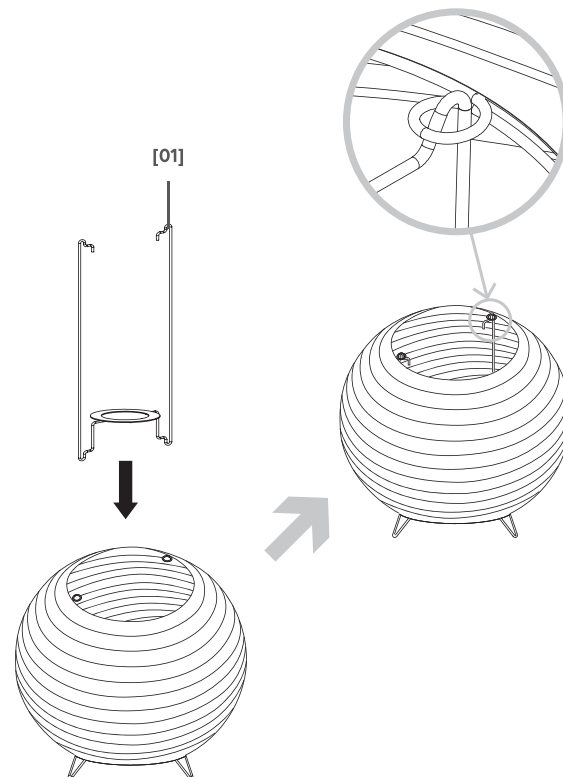

03

[03] x 1

04

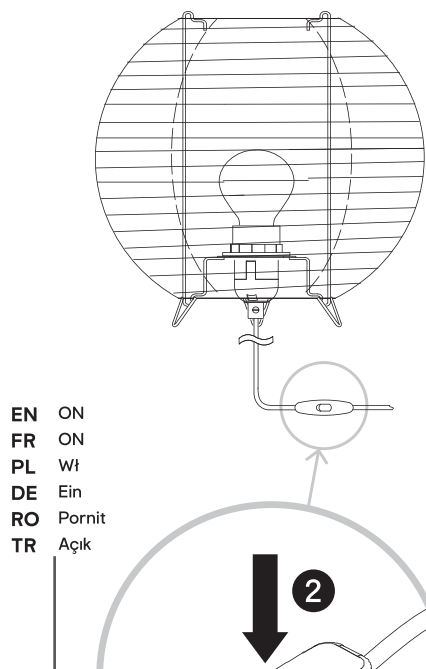
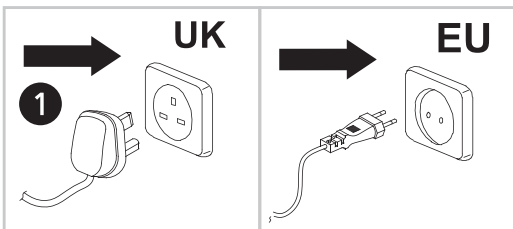
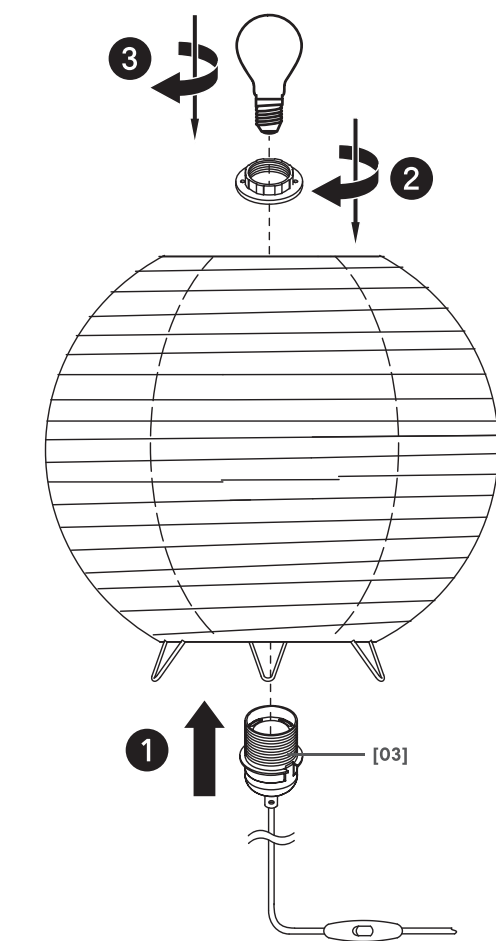

EN ON
 FR ON
 PL Wł
 DE Ein
 RO Pornit
 TR Açık



EN Maintenance FR Maintenance PL Konserwacja
 DE Wartung RO Întreținere TR Onarım

01

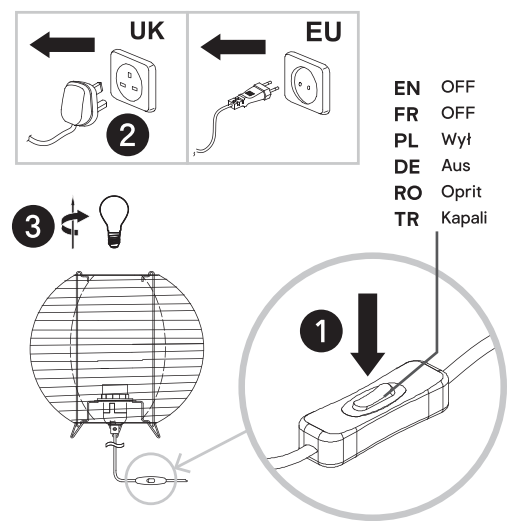

EN OFF
 FR OFF
 PL Wyl
 DE Aus
 RO Oprit
 TR Kapalı

02

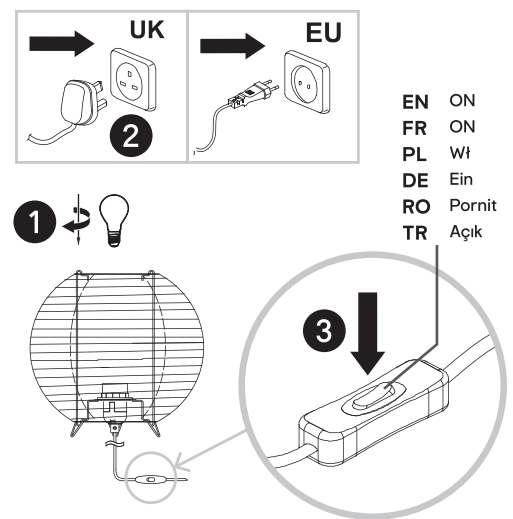

EN ON
 FR ON
 PL Wł
 DE Ein
 RO Pornit
 TR Açık



EN Care FR Entretien PL Pielęgnacja
 DE Pflege RO Îngrijire TR Bakım

EN OFF
 FR OFF
 PL Wyl
 DE Aus
 RO Oprit
 TR Kapalı

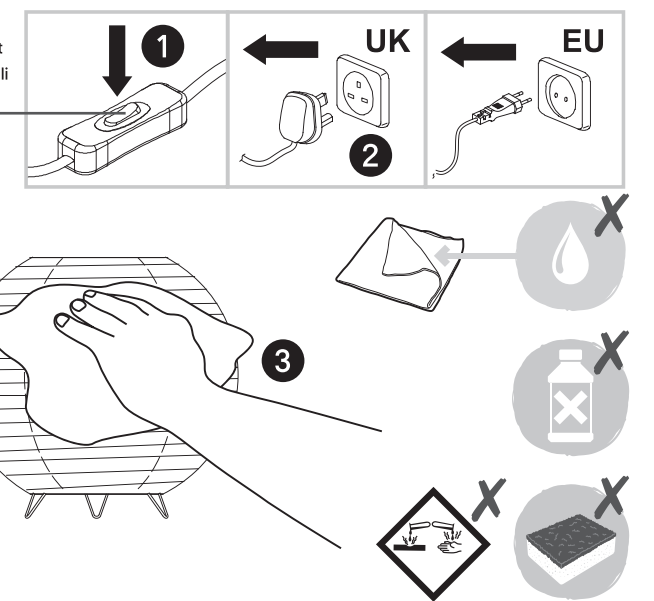

RO



Siguranța

Avertisment

- Aceste instrucțiuni sunt pentru siguranța dumneavoastră. Vă rog să citiți cu atenție aceste instrucțiuni înainte de instalarea produsului și să le păstrați pentru referințe ulterioare.
- Verificați prezența tuturor componentelor.
- Înlăturați întregul ambalaj, punți etc de pe produs.
- Lampa trebuie amplasată pe o suprafață plată, uscată și curată. Nu permiteți ca lampa să fie acoperită; ferii-o de perdele, de cearșafuri etc.
- Acest produs este potrivit pentru utilizarea doar în interiorul clădirilor dar nu pentru zonele în care există în permanență umezeală cum este baia.
- Atenție: Cablul de alimentare trebuie să fie bine fixat, pentru a evita pericolul de electrocutare (evitați formarea de bucle care atâră, deoarece există pericolul ca acestea să fie agățate/prinse în ceva).
- Niciodată nu plasați obiecte pe produs și nici nu agățați nimic de produs.
- Cablul sau cordonul flexibil extern al acestui corp de iluminat nu poate fi înlocuit; în cazul în care cablul se deteriorează, corpul de iluminat trebuie aruncat.
- Atunci când produsul nu luminează după instalare:
< Verificați să nu existe pană de curent
< Verificați ca toate conexiunile să fie securizate
- Dacă aveți dubii despre instalarea /utilizarea acestui produs, consultați un electrician calificat.
- Mereu deconectați produsul cel puțin 10 minute permițând răcirea înaintea activităților de mentenanță sau activităților de ajustare.
- Se recomandă programarea unor intervenții regulate de întreținere, pentru a menține curățenia suprafeței.

Date tehnice

Tensiunea de alimentare:	220-240 V~, 50 Hz
Tip bec:	1 x Max. 40 W E27 (verificați dimensiunile becului în raport cu spațiul disponibil)
	Acest produs respectă cerințele de conformitate ale reglementărilor sau directivelor europene aplicabile.
	Produs clasa II -Dublu izolat - împământarea nu este necesară
	Doar pentru utilizarea în interiorul clădirilor.
	Deșeurile produselor electrice nu trebuie să fie eliminate împreună cu deșeurile menajere. Vă rog să eliminați deșeurile menajere în locurile special amenajate. Contactați autoritățile locale sau magazinul de unde ați achiziționat produsul pentru detalii referitoare la reciclare.
xxWyy	xx-anul; yy-săptămâna din an

TR



Güvenlik

Uyari

- Bu talimatlar güvenliğinizi içindir. Lütfen montajdan önce talimatların tamamını okuyun ve gelecekte başvuru için saklayın.
- Paketi kontrol edin ve listede yer alan tüm parçaların paket içinde bulunduğundan emin olun.
- Üründen tüm paketleme, ambalaj vb. malzemeyi çıkarın.
- Lamba; düz, kuru ve temiz bir zemin üzerine yerleştirilmelidir. Ürünün üzerinin örtülmesini engelleyin; perdelerden, çarşafardan vb. eşyalardan uzak tutun.
- Bu ürün sadece kapalı kullanım için tasarlanmış ve banyo gibi sabit bir nem var yerler için uygun değildir.
- Dikkat: Kablonun yönlendirilmiş olduğundan ve böylece tehlike oluşturmayacağından emin olun (kablunun çekilebileceği/takılabileceği şekilde sallanmasını/dolanmasını önleyin).
- Asla ürünün üzerine bir şey koymayın veya herhangi bir bölümüne bir şey asmayın.
- Harici esnek kablo veya bu armatürün kablosu değiştirilemez. Kablo zarar görürse armatür imha edilmelidir.
- Ürün montajdan sonra yanmıyorsa:
> Elektrik arızası olmadığından emin olun
> Tüm bağlantıların emniyete alındığından emin olun
- Bu ürünün montajı/kullanımı hakkında şüpheniz varsa, yetkili bir elektrikçiye danışın.
- Üründe bakım veya ayar yapmadan önce her zaman ürünün elektrik bağlantısını keserek en az 10 dakika soğumaya bırakın.
- Yüzeyin iyi bir durumda korunması için düzenli bir bakım programının izlenmesi önerilir.

Teknik veriler

Besleme Gerilimi:	220-240 V~, 50 Hz
Ampul Tipi:	1 x Max. 40 W E27 (seçilen ampulun armatürdeki montaj boşluğuna uygunluğunu kontrol ediniz)
	Bu ürün, geçerli Avrupa Tüzüklerinin veya Direktiflerinin uygunluk gerekliliklerine uygundur.
	Sınıf II
	Sadece iç mekan kullanımı için uygundur.
	Kullanılmış elektrikli ürünler ve ev atıklarının birlikte atılmaması gerekir. Elektrikli/Elektronik ürünler veya pil içerisinde bulunan bazı kimyasallar sağlığa ve çevreye zararlı olabilir. Tesislerinin bulunduğu yerlerde geri dönüşümünü sağlayınız. Geri dönüşüm tavsiyesi için yerel yetkililer veya satış noktasından bilgi alınız.
xxWyy	xx-yıl; yy-yılın haftası

Addresses

Manufacturer • Fabricant • Producent • Producător • Fabricante:

UK Manufacturer:
Kingfisher International Products Limited,
3 Sheldon Square, London, W2 6PX,
United Kingdom

EU Manufacturer:

Kingfisher International Products B.V.
Rapenburgerstraat 175E
1011 VM Amsterdam
The Netherlands
www.kingfisher.com/products

EN www.diy.com
www.screwfix.com
www.screwfix.ie

Made in China

To view instruction manuals online, visit www.kingfisher.com/products

FR www.castorama.fr
www.bricodepot.fr

Fabriqué en RPC

Pour consulter les manuels d'instructions en ligne, rendez-vous sur le site www.kingfisher.com/products

PL www.castorama.pl

Wyprodukowano w ChRL

Aby zapoznać się z instrukcją obsługi online, odwiedź stronę www.kingfisher.com/products

RO www.bricodepot.ro

Fabricat în China

Pentru a consulta manualele de instrucțiuni online, vizitați www.kingfisher.com/products

TR İthalatçı Firma:

KOÇTAŞ YAPI MARKETLERİ TİC. A.Ş.
Taşdelen Mah. Sırrı Çelik Bulvarı No: 5
34788 Taşdelen/Çekmeköy/İSTANBUL
Tel: +90 216 4300300
Faks: +90 216 4844313
www.koctas.com.tr

Kullanım kılavuzuna internet üzerinden ulaşmak için www.kingfisher.com/products adresini ziyaret edin

Yetkili servis istasyonları ve yedek parça temini için aşağıda yer alan Koçtaş Müşteri Hattı ve Koçtaş Genel Müdürlük irtibat bilgilerinden faydalanınız.

KOÇTAŞ MÜŞTERİ HİZMETLERİ
0850 209 50 50

AEEE Yönetmeliğine Uygundur.
Menşei: Çin

Taynae

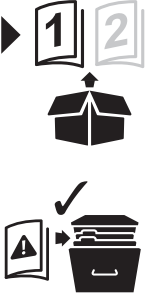





EAN: 5036581098988 / 5059340002057
Model: KD-005-WHT

Safety

Warning

- These instructions are for your safety. Please read through them thoroughly prior to installation and retain them for future reference.
- Check the pack and make sure you have all of the parts listed.
- Remove all packaging, wrap etc from the product.
- The lamp should be placed on a flat, dry and clean surface. Do not allow the lamp to be covered; keep clear of curtains and bedding, etc.
- This product is suitable for indoor use only and not for areas constantly subject to moisture such as bathroom.
- Caution: Ensure the cable is routed so it does not present a hazard (avoid dangling loops where the cable is likely to be pulled/caught).
- Never put anything on the product or hang anything on any part of this product.
- The external flexible cable or cord of this luminaire cannot be replaced; if the cord is damaged, the luminaire must be destroyed.
- When the product does not light after installation:
 - > Ensure there is no electricity failure
 - > Ensure all the connections are secured
- If you have any doubt about installation/use of this product, consult a qualified electrician.
- Always disconnect the product from mains at least 10 minutes allowing to cool down before any maintenance or adjustment.
- It is recommended to have a regular schedule of care and maintenance to keep the surface condition well.

Technical Data





Supply Voltage:	220-240 V~, 50 Hz
Bulb Type:	1 x Max. 40 W E27 (check bulb dimensions in relation to space available)
	This product complies with conformity requirements of the applicable European Regulations or Directives.
	This product complies with conformity requirements of the applicable UK Regulations.
	Class II product - Double Insulated - No earth required
	For indoor use only.
	Waste electrical products should not be disposed of with household waste. Please recycle where facilities exist. Check with your Local Authority or local store for recycling advice.
xxWyy	xx-year; yy-week of the year

Sécurité

Avertissement

- Les consignes suivantes visent à assurer votre sécurité. Veuillez les lire attentivement avant d'installer et conserver ces consignes pour référence future.
- Retirez le produit de l'emballage.
- La lampe doit être placée sur une surface plane, sèche et propre. Évitez toute situation dans laquelle la lampe pourrait se trouver recouverte ; conservez-la à l'écart des rideaux, de la literie, etc.
- Ce produit est exclusivement conçu pour être utilisé à l'intérieur et ne convient pas aux endroits qui présentent une humidité constante telles que dans les salles de bains.
- Attention : assurez-vous que l'acheminement du câble ne présente aucun danger (évitiez les boucles pendantes, où le câble risque d'être arraché/accroché).
- Ne placez ni n'accrochez jamais d'objet sur ce produit.
- Le câble souple externe ou le cordon de ce luminaire ne peut pas être remplacé ; si le cordon est endommagé, le luminaire doit être détruit.
- Si le produit ne s'allume pas après l'installation :
 - > S'assurer qu'il n'y a pas de panne électrique
 - > S'assurer que tous les branchements soient faits
- En cas de doutes concernant le montage ou l'utilisation de ce produit, consultez un électricien professionnel.
- Toujours débrancher le produit au secteur au moins 10 minutes avant toute opération de maintenance ou de réglage, afin de s'assurer de son refroidissement.
- Il est recommandé d'effectuer un nettoyage et un entretien réguliers pour conserver un bon état de surface.

Caractéristiques

Tension d'alimentation :	220-240 V~, 50 Hz
Type d'ampoule :	1 x Max. 40 W E27 (vérifiez au préalable les dimensions de l'ampoule par rapport à l'espace disponible)
	Ce produit est conforme aux exigences de conformité des règlements ou directives européennes applicables.
	Produit de classe II - Double isolation - Le branchement au cable de terre n'est pas nécessaire
	Pour utilisation à l'intérieur uniquement.
	Les produits électriques usagés ne doivent pas être jetés avec les ordures ménagères. Veuillez utiliser les aménagements spécifiques prévus pour les traiter. Renseignez-vous auprès des autorités locales ou du revendeur pour obtenir la marche à suivre en matière de recyclage.
xxWyy	xx-année ; yy-semaine de l'année







Bezpieczeństwo

Ostrzeżenie

- Niniejsze instrukcje służą Twojemu bezpieczeństwu. Prosimy dokładnie je przeczytać przed instalacją i zachować do wglądu.
- Sprawdź opakowanie i upewnij się, że znajdują się w nim wszystkie części.
- Usuń całe opakowanie, folię itd. z produktu.
- Lampę należy umieścić na płaskim, suchym i czystym podłożu. Nie zastaniać lampy; trzymać ją z dala od zasłon, pościeli itd.
- Produkt ten jest zaprojektowany wyłącznie do użytku wewnątrz pomieszczeń i nie nadaje się do miejsca, które ma stałą wilgotność, takich jak łazienki.
- Przestroga: Upewnij się, że kabel jest poprowadzony w sposób nie stwarzający zagrożenia (unikaj zawieszania kabla w sposób, który umożliwia jego pociągnięcie/zahaczenie).
- Nigdy nie umieszczaj ani nie wieszaj na produkcie jakichkolwiek przedmiotów.
- Elastyczny przewód zewnętrzny lampy nie podlega wymianie; jeśli zostanie uszkodzony, należy oddać lampę na złom.
- Gdy produkt nie zaświeci się po instalacji, upewnij się że:
 - > nie ma awarii instalacji elektrycznej,
 - > wszystkie połączenia są prawidłowe i bezpiecznie wykonane
- Jeśli masz jakiegokolwiek wątpliwości dotyczące montażu/użycia niniejszego produktu, skonsultuj się z wykwalifikowanym elektrykiem.
- Zawsze odłącz produkt od zasilania przed wykonaniem naprawy, konserwacji lub regulacji, minimum 10 minut przed wykonaniem tych czynności, aby produkt mógł się schłodzić.
- Zaleca się prowadzenie regularnego harmonogramu konserwacyjnego, aby utrzymywać powierzchnię w dobrym stanie.

Dane techniczne





Napięcie znamionowe:	220-240 V~, 50 Hz
Rodzaj żarówki:	1 x Maks. 40 W E27 (sprawdź rozmiar żarówek aby pasował też pod względem wielkości w oprawie)
	Ten produkt spełnia wymogi zgodności zawarte w odnośnych rozporządzeniach lub dyrektywach unijnych.
	Klasa II
	Tylko do użytku domowego, wewnątrz pomieszczeń.
	Zużytych urządzeń elektrycznych nie należy wyrzucać razem z odpadami komunalnymi. Należy oddać je do sklepów Castoramy w wyznaczonych miejscach. Wskazówki dotyczące recyklingu można uzyskać od lokalnych władz lub od sprzedawcy.
xxWyy	xx-rok; yy-tydzień roku

Sicherheit

Warnung

- Die in dieser Gebrauchsanleitung enthaltenen Hinweise dienen Ihrer Sicherheit. Bitte lesen Sie sie sorgfältig durch, bevor Sie das Gerät montieren und bewahren Sie die Anleitung für spätere Rückfragen auf.
- Prüfen Sie nach Auspacken, ob alle aufgeführten Teile vorhanden sind.
- Entfernen Sie das gesamte Verpackungsmaterial vollständig.
- Die Lampe muss auf einer ebenen, trockenen und sauberen Oberfläche stehen. Achten Sie darauf, dass die Lampe nie abgedeckt wird; halten Sie Abstand zu Vorhängen und Bettwäsche usw.
- Dieses Produkt ist nur zur Verwendung in trockenen Innenräumen geeignet. Es ist nicht zum Betrieb im Badezimmer oder anderen durchgängig feuchten Bereichen geeignet.
- Achtung: Achten Sie darauf, das Kabel so zu führen, dass es keine Gefahr darstellt (vermeiden Sie baumelnde Kabelschleifen, in denen man sich verfangen oder das Kabel ziehen kann).
- Verwenden Sie das Produkt keinesfalls, um andere Gegenstände abzustellen oder aufzuhängen.
- Das externe flexible Kabel oder Netzkabel dieser Leuchte kann nicht ersetzt werden; wenn das Netzkabel beschädigt ist, muss die Leuchte vernichtet werden.
- Falls das Gerät nach der Installation nicht leuchtet:
 - > Vergewissern Sie sich, dass die Stromversorgung nicht gestört ist
 - > Vergewissern Sie sich, dass das alle Kabel korrekt angeschlossen sind
- Sollten bei der Montage/ der Bedienung dieses Produktes Zweifel aufkommen, wenden Sie sich an einen fachkundigen Elektriker.
- Wenn Sie das Gerät warten oder justieren möchte, trennen Sie es stets 10 Minuten zuvor vom Netz, damit es abkühlen kann.
- Es wird empfohlen, ein regelmäßiges Pflege- und Wartungsintervall einzuhalten, damit die Oberfläche in gutem Zustand bleibt.

Technische Spezifikationen

Versorgungsspannung:	220-240 V~, 50 Hz
Leuchtmittel-Typ	1 x Max. 40 W E27 (Abmessung des Leuchtmittels im Verhältnis zum verfügbaren Platz überprüfen)
	In Übereinstimmung mit allen einschlägigen EG-Richtlinienanforderungen.
	Sicherheitsklasse II - Doppelt isoliert - Geerdeter Anschluss nicht erforderlich
	Nur für den Innengebrauch geeignet.
	Elektronik-Altgeräte dürfen nicht als Hausmüll entsorgt werden. Recyceln Sie das Gerät, wenn möglich. Bei Fragen zur umweltgerechten Entsorgung, kontaktieren Sie bitte Ihre Behörde oder einen Händler vor Ort.
xxWyy	xx-Jahr; yy-Woche des Jahres