

21217KF / 21227KF
 EAN: 3663602632016 / 3663602632023

V30821 BX220IM/B3

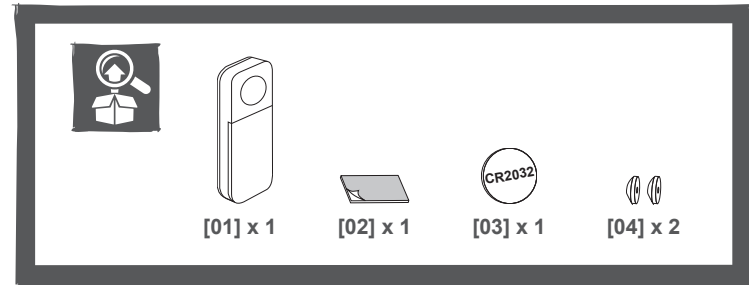

EN IMPORTANT - Please read carefully the safety guide before use.
FR S'il vous plaît lire attentivement le guide de sécurité avant utilisation.

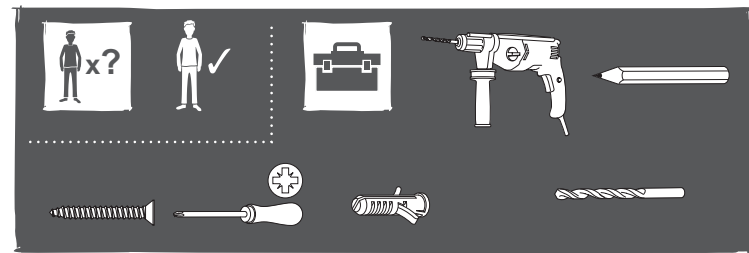

EN Product description **FR** Description du produit

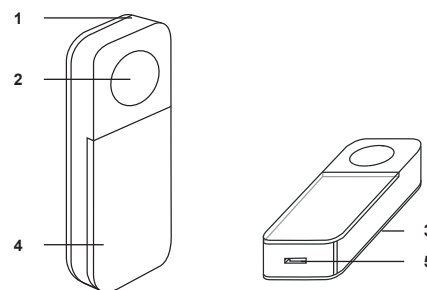

EN 1. Wireless bell push 2. Push button 3. Backplate 4. Nameplate 5. Clip release
FR 1. Bouton de sonnerie sans fil 2. Bouton-poussoir 3. Plaque arrière 4. Plaque porte-nom 5. Clip d'ouverture

EN Before you start **FR** Avant de commencer

- EN**
- For domestic use only.
 - Children or persons unable to use this appliance safely should never use this door chime.
 - Please dispose of packaging responsibly and keep out of reach of children.
 - Do not use zinc batteries.
 - Compatible with the Liam, Reese and Audric Ranges.
- FR**
- Usage domestique uniquement.
 - Les enfants ou les personnes incapables d'utiliser cet appareil en toute sécurité ne doivent pas utiliser ce carillon.
 - Jeter les emballages de façon responsable et les tenir hors de la portée des enfants.
 - Ne pas utiliser de piles au zinc.
 - Compatible avec les gammes Liam, Reese et Audric.

EN Installation **FR** Installation

01

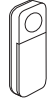

[01] x 1
 [03] x 1

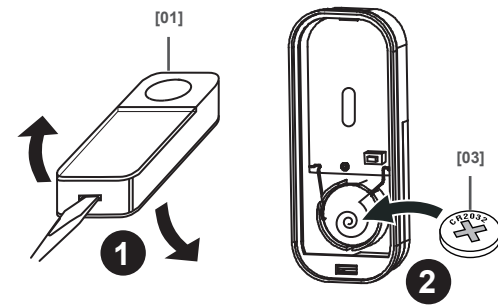

2A



[02] x 1

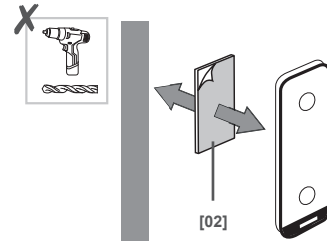

2B



[04] x 2

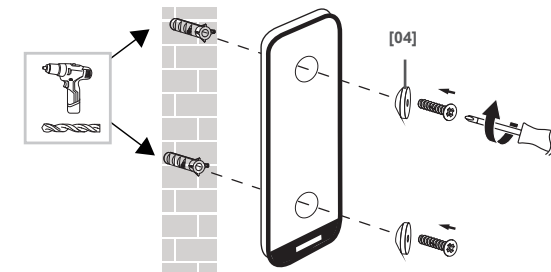

03

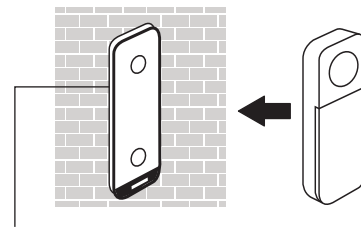

EN * Ensure Rubber Seal is in place
FR * S'assurer que le joint en caoutchouc est en place

EN Use **FR** Utilisation

01

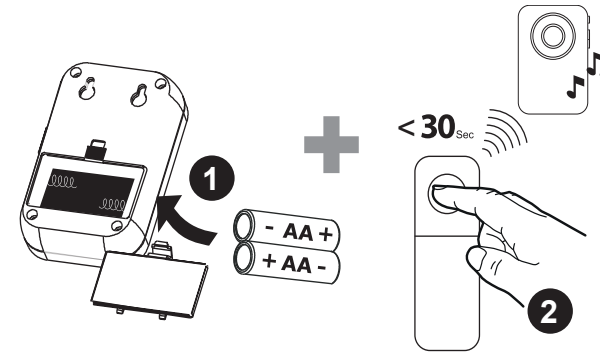

02

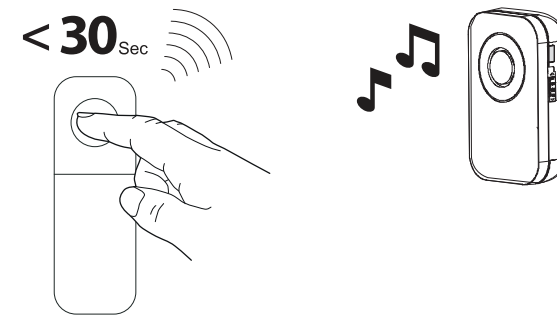

03

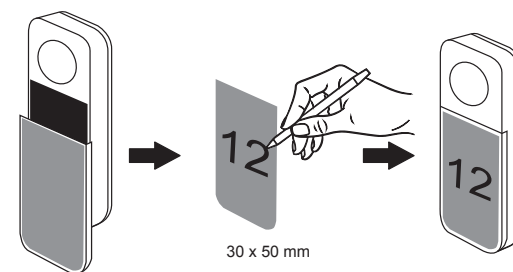

EN Maintenance **FR** Maintenance

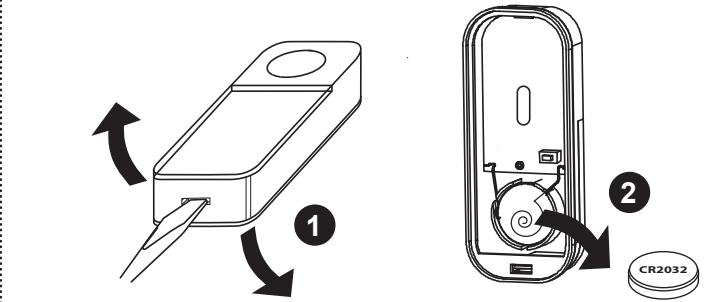

EN Care **FR** Entretien

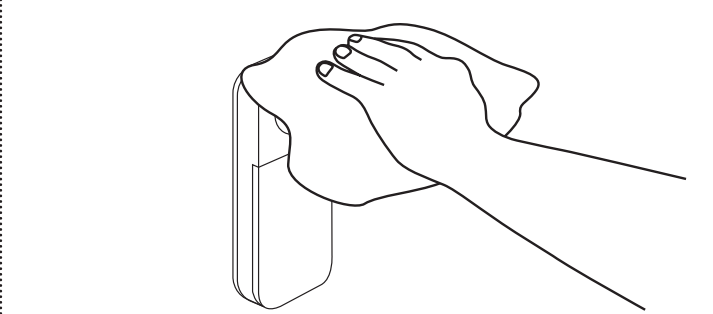

EN Safety

- The ventilation should not be impeded by covering the ventilation openings with items, such as newspapers, tablecloths, curtains, etc...
- DO NOT allow this product to come into direct contact with heat or a naked flame
- The normal operation of the product may be disturbed by strong electromagnetic interference.
- This equipment is intended for domestic use only.
- The appliance shall not be exposed to dripping or splashing.
- No objects filled with liquids, such as vases, shall be placed on the appliance.
- Keep a minimum distance of 10 cm around the product for sufficient ventilation.
- Ensure the bell push is not mounted where it could become immersed by water/rain.
- DO NOT allow children to play with this appliance.
- Use apparatus in moderate climates.
- This product belongs to receiver category 2.
- Warning** - To prevent injury, this apparatus must be securely attached to the floor/wall in accordance with installation instructions.

Battery Warnings

- Only the recommended batteries should be used.
- Remove batteries from product when not in use for long periods of time.
- Keep this product out of the reach of small children.
- Store unused batteries in their original packaging.
- Dispose of used batteries responsibly.
- An adult must carry out battery replacement and installation.
- Remove exhausted batteries from this product.
- DO NOT dispose of batteries in a fire, batteries may explode or leak.
- DO NOT short-circuit the battery terminals.
- DO NOT mix used and new batteries.
- DO NOT mix alkaline standard, lithium or rechargeable batteries.
- DO NOT use rechargeable batteries in this product.
- DO NOT recharge non-rechargeable batteries.
- DO NOT allow any part to come in contact with heat or a direct flame.
- DO NOT allow water to come into contact with the batteries or wiring.
- Install carefully to prevent any damage to the batteries.
- When installing batteries in the battery compartments, ensure the batteries are placed as marked (+) (-).
- Do not ingest battery.
- This product contains a coin / button cell battery. If the coin / button cell battery is swallowed, it can cause severe internal burns in just 2 hours and can lead to death.
- Keep new and used batteries away from children. If the battery compartment does not close securely, stop using the product and keep it away from children.
- If you think batteries might have swallowed or placed inside any part of the body, seek immediate medical attention.

FR Sécurité

- Les ouvertures de ventilation ne doivent pas être obstruées par des journaux, nappes, rideaux ou autres objets divers.
- NE PAS exposer ce produit directement à la chaleur ou à une flamme nue.
- Le fonctionnement normal du produit peut être perturbé par de fortes interférences électromagnétiques.
- Cet équipement est destiné à un usage domestique uniquement.
- L'appareil ne doit pas être exposé à des égouttements ou à des éclaboussures.
- Aucun objet rempli de liquides, tel qu'un vase, ne doit être placé sur l'appareil.
- Maintenir une distance minimale de 10 cm autour du produit pour une ventilation suffisante.
- S'assurer que le bouton de sonnerie n'est pas monté à un endroit susceptible d'être immergé par l'eau ou la pluie.
- NE PAS autoriser les enfants à jouer avec cet appareil.
- Utiliser l'appareil dans un climat modéré.
- Ce produit appartient à la catégorie de récepteur 2.
- Avvertissement** : pour éviter les blessures, cet appareil doit être solidement fixé au sol ou au mur conformément aux instructions d'installation.

Mises en garde concernant les piles

- Utiliser uniquement les piles recommandées.
- Retirer les piles du produit lorsque celui-ci n'est pas utilisé pendant de longues périodes. Tenir ce produit hors de la portée des jeunes enfants.
- Ranger les piles non usagées dans leur emballage d'origine. Mettre les piles au rebut en agissant de façon responsable.
- Le remplacement et l'installation des piles doivent être effectués par un adulte. Retirer les piles usagées du produit.
- NE PAS jeter les piles au feu : celles-ci risqueraient d'exploser ou de fuir. NE PAS court-circuiter les bornes de piles.
- NE PAS mélanger des piles neuves et usagées.
- NE PAS mélanger des piles alcalines standard, au lithium ou rechargeables.
- NE PAS utiliser de piles rechargeables dans ce produit. NE PAS recharger les piles non rechargeables.
- NE PAS exposer les pièces à une source de chaleur ou une flamme directe. NE PAS exposer les piles ou les fils à l'eau. Installer avec précaution pour éviter tout dommage aux piles
- Lors de l'installation des piles dans le compartiment, veiller à placer les piles selon les indications (+) et (-).
- Ne pas ingérer la pile.
- Ce produit contient une pile bouton. L'ingestion de la pile bouton peut provoquer de graves brûlures internes en seulement 2 heures et s'avérer fatale.
- Tenir les piles neuves et usagées hors de portée des enfants. Si le compartiment à piles ne se ferme pas correctement, cesser d'utiliser le produit et le tenir hors de la portée des enfants.
- En cas de soupçon d'ingestion ou d'insertion d'une pile dans le corps, consulter immédiatement un médecin.

Manufacturer • Fabricant :

UK Manufacturer:
Kingfisher International Products Limited,
3 Sheldon Square, London, W2 6PX,
United Kingdom

EU Manufacturer:
Kingfisher International Products B.V.
Rapenburgstraat 175E
1011 VM Amsterdam, The Netherlands
www.kingfisher.com/products

EN www.diy.com
www.screwfix.com
www.screwfix.ie

To view instruction manuals online, visit www.kingfisher.com/products

Made in China

FR www.castorama.fr
www.bricodepot.fr

Pour consulter les manuels d'instructions en ligne, rendez-vous sur le site www.kingfisher.com/products

Fabriqué en Chine









 (EN) EU DECLARATION OF CONFORMITY (FR) DÉCLARATION UE DE CONFORMITÉ (PL) DEKLARACJA ZGODNOŚCI UE (RO) DECLARAȚIA UE DE CONFORMITATE UE (ES) DECLARACIÓN UE DE CONFORMIDAD (PT) DECLARAÇÃO DE CONFORMIDADE UE		
Product/Produit/Produkt/Produsul/Producto/Produto		
<ul style="list-style-type: none"> • Product name – Refer to below list • Product model: Refer to below list Batch number range: 21W33 to 23W33 		
Name and address of the manufacturer or his authorised representative: Nom et adresse du fabricant ou de son mandataire: Nazwa i adres producenta lub jego upoważnionego przedstawiciela: Denemirea și adresa producătorului sau a reprezentantului său autorizat: Nombre y dirección del fabricante o de su representante autorizado: Nome e endereço do fabricante ou do respetivo mandatário:		
Kingfisher International Products B.V., Rapenburgstraat 175E, 1011 VM Amsterdam, The Netherlands		
This declaration of conformity is issued under the sole responsibility of the manufacturer: La présente déclaration de conformité est établie sous la seule responsabilité du fabricant: Niniejsza deklaracja zgodności wydana zostaje na wyłączną odpowiedzialność producenta: Declarația de conformitate este emisă pe răspunderea exclusivă a producătorului: La presente declaración de conformidad se expide bajo la exclusiva responsabilidad del fabricante: A presente declaração de conformidade é emitida sob a exclusiva responsabilidade do fabricante:		
Object of the declaration/Objet de la déclaration/Przedmiot deklaracji/Obiectul declarației/Objeto da declaração		
Product/Produit/Produkt/Produsul/Producto/Produto	Model/Modèle/Model/Modelo/Modelo/Modelo	EAN
Wireless set of pluggable bell and button, Carillon et bouton sans fil enfilable	21222KF-FR	3663602631958
Bezprzewodowy wtykany z przyciskiem. Set wireless sonerie cu introducere în priză și buton. Juego inalámbrico de timbre enchufable y pulsador. Conjunto sem fios de campainha conectável e botão.	21222WKF-FR	3663602482390
Wireless set of pluggable bell with socket and button, Carillon et bouton sans fil enfilable + prise intégrée. Zestaw dzwonek bezprzewodowy wtykany z gniazdem i przyciskiem. Set wireless sonerie conectabilă cu priză și buton. Juego inalámbrico de timbre enchufable y pulsador. Conjunto sem fios de campainha conectável com tomada e botão	21222KF-UK	3663602631965
Wireless set of pluggable bell with socket and button, Carillon et bouton sans fil enfilable + prise intégrée. Zestaw dzwonek bezprzewodowy wtykany z gniazdem i przyciskiem. Set wireless sonerie conectabilă cu priză și buton. Juego inalámbrico de timbre enchufable y pulsador. Conjunto sem fios de campainha conectável com tomada e botão	21223KF-FR	3663602631972
Wireless button, Bouton sans fil, Przycisk dzwonekowy bezprzewodowy, Buton sonerie wireless, Pulsador timbre inalámbrico. Botão sem fios	21223WKF-FR	3663602482413
Wireless button, Bouton sans fil, Przycisk dzwonekowy bezprzewodowy, Buton sonerie wireless, Pulsador timbre inalámbrico. Botão sem fios	21223KF-SH	3663602631989
Wireless button, Bouton sans fil, Przycisk dzwonekowy bezprzewodowy, Buton sonerie wireless, Pulsador timbre inalámbrico. Botão sem fios	21223KFK-UK	3663602631996
Wireless button, Bouton sans fil, Przycisk dzwonekowy bezprzewodowy, Buton sonerie wireless, Pulsador timbre inalámbrico. Botão sem fios	21223WKF-UK	3663602482437
Wireless button, Bouton sans fil, Przycisk dzwonekowy bezprzewodowy, Buton sonerie wireless, Pulsador timbre inalámbrico. Botão sem fios	21217KF	3663602632016
Wireless button, Bouton sans fil, Przycisk dzwonekowy bezprzewodowy, Buton sonerie wireless, Pulsador timbre inalámbrico. Botão sem fios	21227KF	3663602632023
The object of the declaration described above is in conformity with the relevant Union harmonisation legislation: L'objet de la déclaration décrit ci-dessus est conforme à la législation d'harmonisation de l'Union applicable: Wymieniony powyżej przedmiot niniejszej deklaracji jest zgodny z odnośnymi wymaganiami unijnego prawodawstwa harmonizacyjnego: Obiectul declarației descris mai sus este în conformitate cu legislația relevantă de armonizare a Uniunii: El objeto de la declaración descrita anteriormente es conforme con la legislación de armonización pertinente de la Unión: O objeto da declaração acima descrito está em conformidade com a legislação de harmonização da União aplicável:		
2014/53/EU as amended Radio Equipment Directive 2014/53/EU tel que modifié Directive relative aux équipements radio électriques 2014/53/EU zgodnie z wprowadzonymi poprawkami Dyrektywa urządzeń radiowych 2014/53/EU cum a fost modificată Directiva privind echipamentele radio 2014/53/EU según enmendado Directiva relativa a los equipos radioeléctricos 2014/53/EU conforme alterado Directiva relativa a equipamentos de rádio 2011/65/EC as amended Directive RoHS Restriction of the use of certain hazardous substances in electrical and electronic equipment Directivă 2011/65/UE relative à la limitation de l'utilisation de certaines substances dangereuses dans les équipements électriques et électroniques 2011/65/EC zgodnie z wprowadzonymi poprawkami Dyrektywa w sprawie ograniczenia stosowania niektórych niebezpiecznych substancji w sprzęcie elektrycznym i elektronicznym 2011/65/EC cum a fost modificată Directiva Restrictiile de utilizare a anumitor substanțe periculoase în echipamentele electrice și electronice 2011/65/UE según enmendado Directiva sobre restricciones a la utilización de determinadas sustancias peligrosas en aparatos eléctricos y electrónicos 2011/65/EC conforme alterado Directiva Restrição do uso de determinadas substâncias perigosas em equipamentos eléctricos e electrónicos 2009/125/EC as amended Directive on Ecodesign Requirements for Energy-Related Products 2009/125/EC tel que modifié D'exigences en matière d'écoconception applicables aux produits liés à l'énergie 2009/125/WE zgodnie z wprowadzonymi poprawkami dotyczących ekoprojektu dla produktów związanych z energią 2009/125/CE cum a fost modificată cerințele în materie de proiectare ecologică aplicabile produselor cu impact energetic 2009/125/CE según enmendado Directiva de diseño ecológico aplicables a los productos relacionados con la energía 2009/125/CE conforme alterado concepção ecológica dos produtos relacionados com o consumo de energia		
References to the relevant harmonised standards used or references to the other technical specifications in relation to which conformity is declared: Références des normes harmonisées pertinentes appliquées, y compris la date de celles-ci, ou des autres spécifications techniques, y compris la date de celles-ci, par rapport auxquelles la conformité est déclarée: Odwolania do odnośnych norm zharmonizowanych, które zastosowano, wraz z datą normy, lub do innych specyfikacji technicznych, wraz z datą specyfikacji, w odniesieniu do których deklarowana jest zgodność: Trimiteri la standardele armonizate relevante folosite, inclusiv data standardului, sau trimiteri la celelalte specificații tehnice, inclusiv data specificațiilor, în legătură cu care se declară conformitatea: Referências às normas harmonizadas pertinentes utilizadas, incluindo as datas das normas, ou referências a las otras especificaciones técnicas, incluidas las fechas de las especificaciones, respecto a las cuales se declara la conformidad: Referências às normas harmonizadas aplicáveis utilizadas, incluindo a data da norma, ou às outras especificações técnicas, incluindo a data da especificação, em relação às quais é declarada a conformidade:		
EN 62368-1:2014+A11:2017 EN 62479:2010 EN 300 220-2 V3.1.1 EN 301 489-1 V2.2.3 EN 301 489-3 V2.1.1 (EC) No. 1275/2008 + (EU) No. 801/2013		
Signed for and on behalf of/Signé par et au nom de/Podpisano w imieniu/Semnat pentru și În numele/Firmado en nombre de/Assinado por e em nome de: Kingfisher International Products B.V., Rapenburgstraat 175E, 1011 VM Amsterdam, The Netherlands		
David Awe Group Quality Director		: [06/08/2021]

 (UK) DECLARATION OF CONFORMITY		
Product		
<ul style="list-style-type: none"> • Product name – Refer to below list • Product model: Refer to below list • Batch number range: 21W33 to 23W33 		
Name and address of the manufacturer or his authorised representative: Kingfisher International Products Limited 3 Sheldon Square London W2 6PX United Kingdom		
This declaration of conformity is issued under the sole responsibility of the manufacturer.		
Object of the declaration		
Product	Model	EAN
Wireless set of pluggable bell and button	21222KF-UK	3663602631965
Wireless set of pluggable bell and button	21222WKF-UK	3663602482406
Wireless set of pluggable bell with socket and button	21223KF-UK	3663602631996
Wireless set of pluggable bell with socket and button	21223WKF-UK	3663602482437
Wireless button	21217KF	3663602632016
Wireless button	21227KF	3663602632023
The object of the declaration described above is in conformity with the relevant legislation: Radio Equipment Regulations 2017 as amended The Restriction of the use of Certain Hazardous Substances in Electrical and Electronic Equipment Regulations 2012 as amended The Ecodesign for Energy-Related Products and Energy Information Regulations 2021 References to the relevant designated standards used or references to the other technical specifications in relation to which conformity is declared: EN 62368-1:2014+A11:2017 EN 62479:2010 EN 300 220-2 V3.1.1 EN 301 489-1 V2.2.3 EN 301 489-3 V2.1.1 (EC) No. 1275/2008 + (EU) No. 801/2013 Signed for and on behalf of: Kingfisher International Products Limited 3 Sheldon Square London W2 6PX United Kingdom		
David Awe Group Quality Director		On [06/08/2021]



EN Technical Data

FR Caractéristiques

EN	FR
Push button - 21217KF / 21227KF Alimentation : Power supply: 1 x CR2032 3 V  Max distance between bell bush button and doorbell 100 m (in open area) Frequency band: 433.050 - 434.790 MHz Maximum radio-frequency power: 5 dBm Temperature: Max 35 °C	Bouton-poussoir : 21217KF / 21227KF Alimentation : 1 x CR2032 3 V  Distance maximale entre le bouton-poussoir et la sonnette 100 m (en zone ouverte) Bande de fréquence : 433,050 - 434,790 MHz Puissance de radiofréquence maximale : 5 dBm Température : Max 35 °C
IP44 	Splash-proof Protégé contre les projections d'eau en tous sens
 Direct current (DC Power)	Courant continu (alimentation CC)
 	Apparatus contains a user-replaceable coin/button cell battery. L'appareil contient une pile bouton remplaçable par l'utilisateur.
 	This product complies with conformity requirements of the applicable European Regulations or Directives Ce produit est conforme aux exigences de conformité des règlements ou directives européennes applicables
	Waste electrical products should not be disposed of with household waste. Please recycle where facilities exist. Check with your Local Authority or local store for recycling advice. Les produits électriques usagés ne doivent pas être jetés avec les ordures ménagères. Veuillez utiliser les aménagements spécifiques prévus pour les traiter. Renseignez-vous auprès des autorités locales ou du revendeur pour obtenir la marche à suivre en matière de recyclage.
xxWyy	xx-year; yy-week of the year xx-année ; yy-semaine de l'année

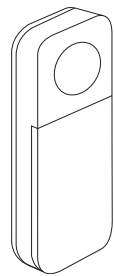

21217KF / 21227KF
 EAN: 3663602632016 / 3663602632023

V30821 BX220IM/B3



- PL Proszę dokładnie zapoznać się z instrukcją bezpieczeństwa przed użyciem.
- RO Vă rugăm să citiți cu atenție ghidul de siguranță înainte de utilizare.
- ES Por favor, lea atentamente la guía de seguridad antes de su uso.
- PT Por favor, leia atentamente o guia de segurança antes de usar.

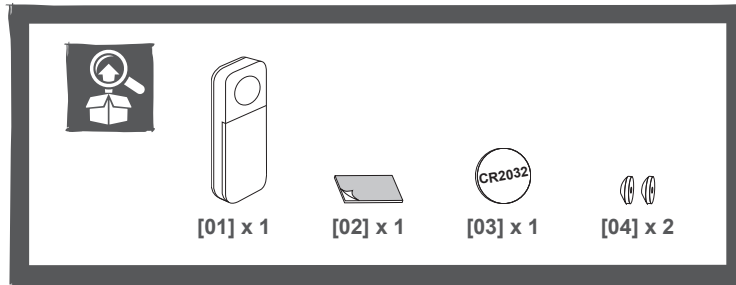
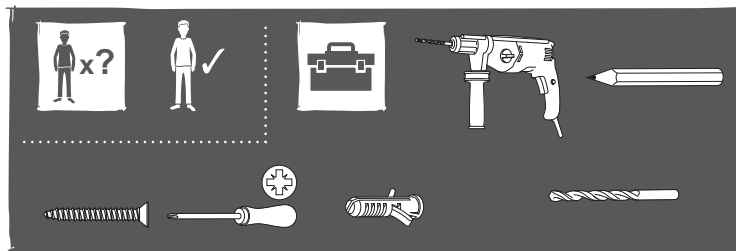

- PL Opis produktu
- RO Descrierea produsului
- ES Descripción del producto
- PT Descrição do produto

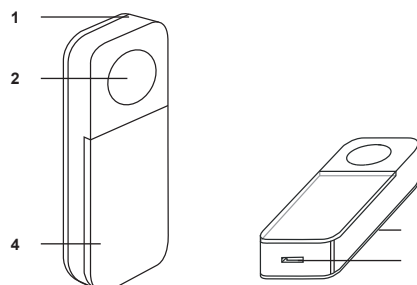

- PL 1. Bezprzewodowy przycisk dzwonkowy 2. Przycisk 3. Płytkę tylną 4. Tabliczka z nazwiskiem 5. Zwolnienie zaczepu
- RO 1. Buton de sonerie wireless 2. Buton 3. Șild 4. Plăcuță de identificare 5. Eliberare clemă
- ES 1. Pulsador de timbre inalámbrico 2. Pulsador 3. Placa trasera 4. Placa de nombre 5. Ranura de apertura
- PT 1. Botão da campainha sem fios 2. Botão de pressão 3. Placa traseira 4. Placa de nome 5. Libertação da tampa

- PL Przed rozpoczęciem użytkowania
- RO Înainte de prima utilizare
- ES Antes de empezar
- PT Antes de começar

- PL Wyłącznie do użytku w gospodarstwie domowym.
- PL Dzieci i osoby niemogące korzystać z tego urządzenia w bezpieczny sposób nigdy nie powinny tego robić.
- PL Należy w sposób odpowiedzialny zutylizować opakowania i przechowywać je poza zasięgiem dzieci.
- PL Nie wolno używać baterii cynkowych.
- PL Zgodność z serią Liam, Reese i Audric.

- RO Numai pentru uz casnic.
- RO Copiii sau persoanele care nu pot utiliza acest aparat în siguranță nu trebuie să utilizeze niciodată această sonerie pentru ușă.
- RO Eliminați ambalajul la deșeurile în mod responsabil și nu îl lăsați la îndemâna copiilor.
- RO Nu utilizați baterii cu zinc.
- RO Compatibilitate cu gamele Liam, Reese și Audric

- ES Solo para uso doméstico.
- ES Los niños o las personas que no puedan utilizar este aparato de forma segura no deben utilizar nunca este pulsador timbre.
- ES Deseche el embalaje de forma responsable y manténgalo fuera del alcance de los niños.
- ES No utilice pilas de zinc.
- ES El producto es compatible con las gamas Liam, Reese y Audric.

- PT Exclusivo para uso doméstico.
- PT Crianças ou pessoas incapazes de utilizar este aparelho em segurança nunca devem utilizar esta campainha de porta.
- PT Elimine o material da embalagem de forma responsável e mantenha-o fora do alcance das crianças.
- PT Não utilize pilhas de zinco.
- PT Compatível com as gamas Liam, Reese e Audric.

- PL Instalacja
- RO Instalare
- ES Instalación
- PT Instalação

01

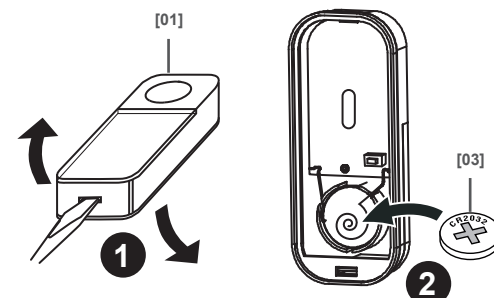

2A

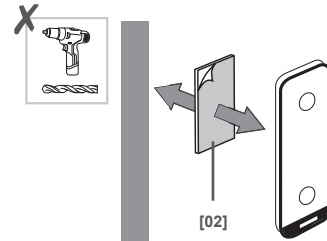

2B

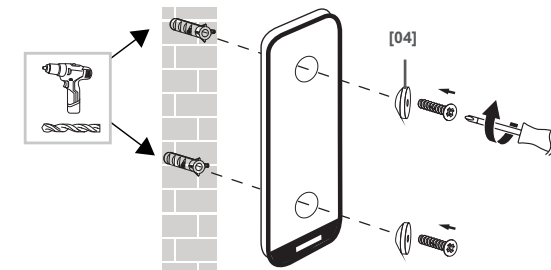

03

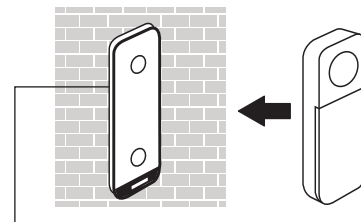

- PL * Upewnnić się, że gumowa uszczelka jest na swoim miejscu
- RO * Asigurați-vă că izolația din cauciuc este la locul ei
- ES * Compruebe que la junta de goma esté en su sitio
- PT * Certifique-se de que o vedante de borracha está colocado corretamente



- PL Użytkowanie
- RO Utilizare
- ES Uso
- PT Utilização

01

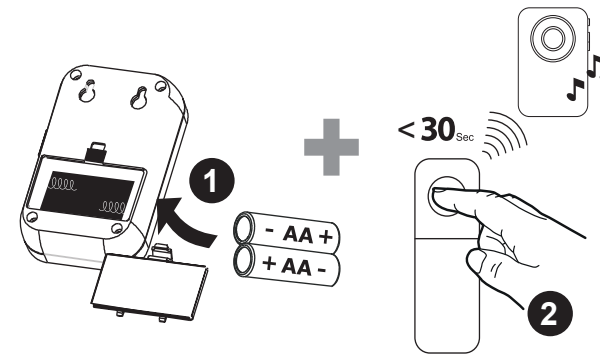

02

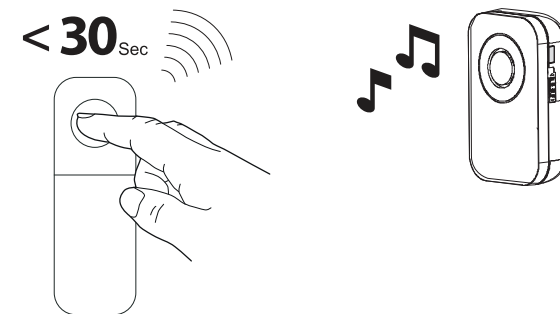

03

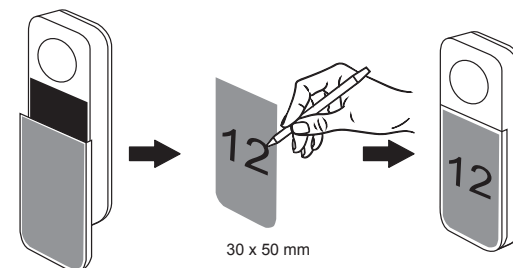

- PL Konserwacja
- RO Întreținere
- ES Mantenimiento
- PT Manutenção

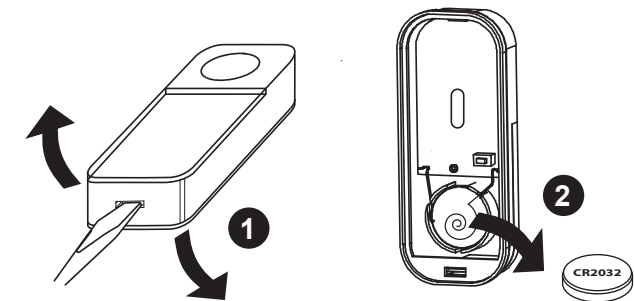

- PL Pielęgnacja
- RO Îngrijire
- ES Cuidados
- PT Cuidados

